

TOP

METAL FURNITURE



Furniture you can depend on





More than 28 years of experience in the production of metal furniture, allows us to present you our offer of most popular range. We are the furniture manufacturer of:

- office: filing and cabinets for documents, desks, tables, computer tables,
- social: wardrobes lockers, lockers with compartments,
- school: wardrobes lockers, furniture for teachers' room,
- workshop: workbenches, including the new series „Techno“, cabinets and workshop cupboards, workshop wall for tools,
- medical: medical cabinets, surgical tables, bedside cabinets,
- cabinets with HPL laminate: swimming pools, fitness clubs,
- gastronomy: tables, cabinets, shelves, trolleys tables, through, hoods,
- cabinets and trolleys for computers and laptops,
- movable archive racks,
- safes (0, I, II class), cabinets for documents of class A, B, C, and reinforced cabinets.

We realize our goals by providing customers with high quality products, and various expectations of customers are met thanks to the innovation and the openness of employees. Thanks to our wide range of products to market needs, we can react flexibly to special versions of furniture which are not a problem for us. We offer furniture in different price categories to measure different customers' needs. Of course, it's just part of our production. For details and a wider offer please contact us or our distributor. At the same time we invite you to visit our website www.malow.pl, where you will find also our new products, certificates and current events.

Our offer, thanks to their complexity, allows to equip offices, banks, cloakrooms, offices, archives of many companies, businesses and government offices, schools and libraries, hospitals and doctor's offices, car workshop, garages and others. So we are with our products wherever there are people, documents, clothing, tools, that is EVERYWHERE.

This material presents our latest arrangements. We present the proposals of modern workshops, functional workplaces and social rooms and a new use of steel furniture.

Judge for yourself!



HOME FURNITURE

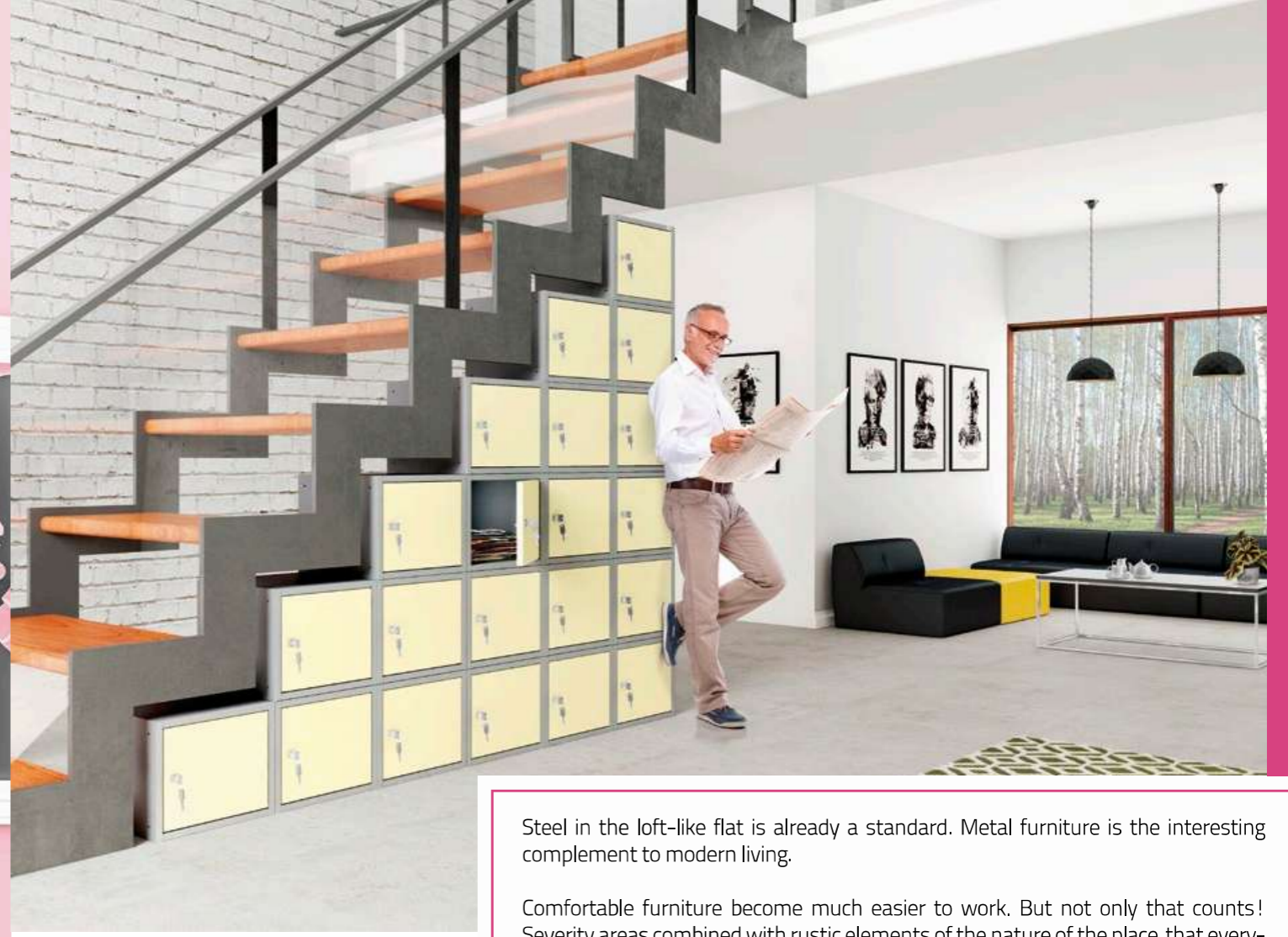

Steel in the loft-like flat is already a standard. Metal furniture is the interesting complement to modern living.

Comfortable furniture become much easier to work. But not only that counts! Severity areas combined with rustic elements of the nature of the place, that everyone will love. The interior of an industrial office will become one of the most interesting and the most pleasant places in the house. Contrary to appearances, the decoration of such space does not necessarily entail high costs. In such a beautiful and unusual place without fear can be a workaholic ☺.

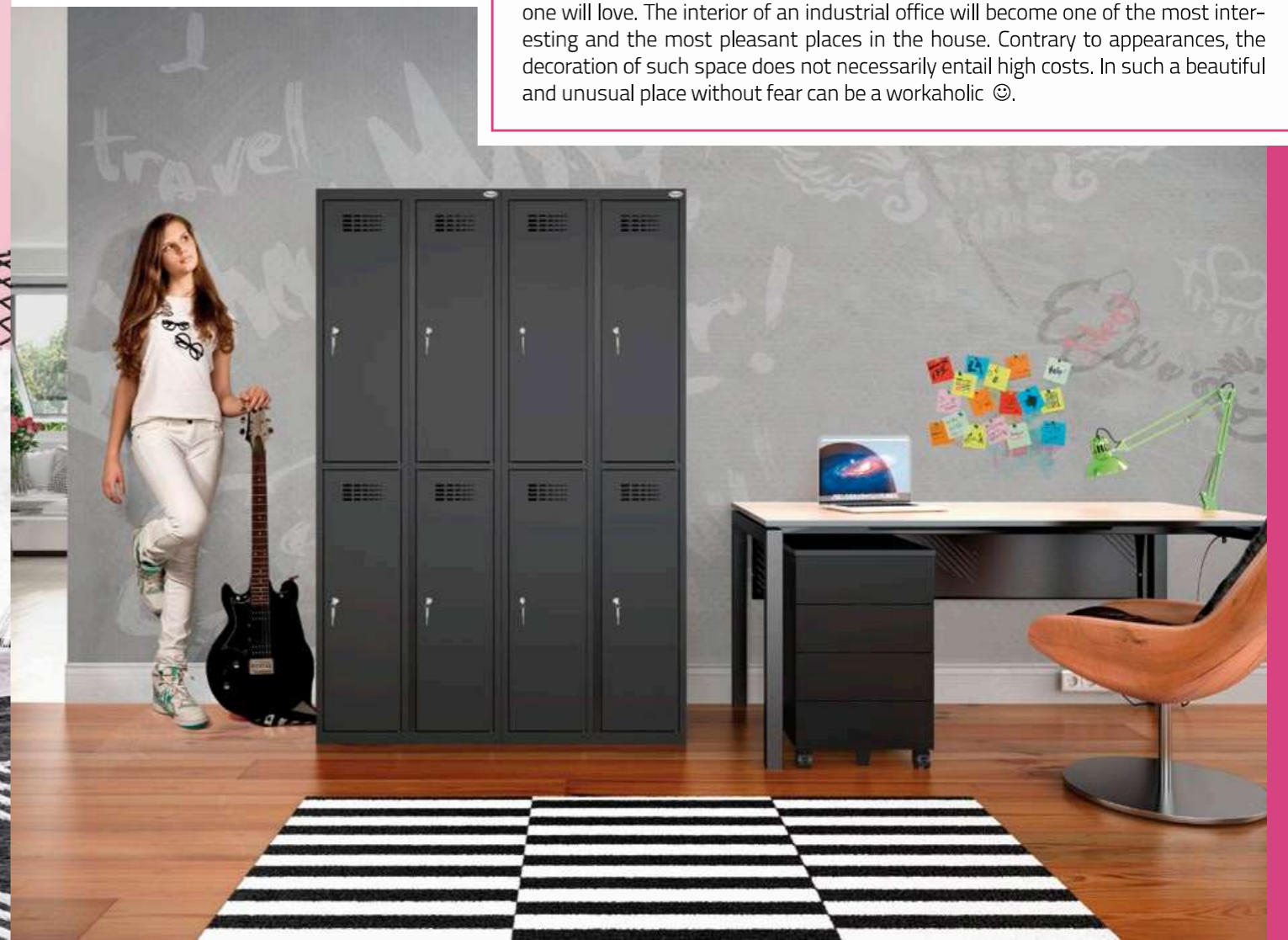

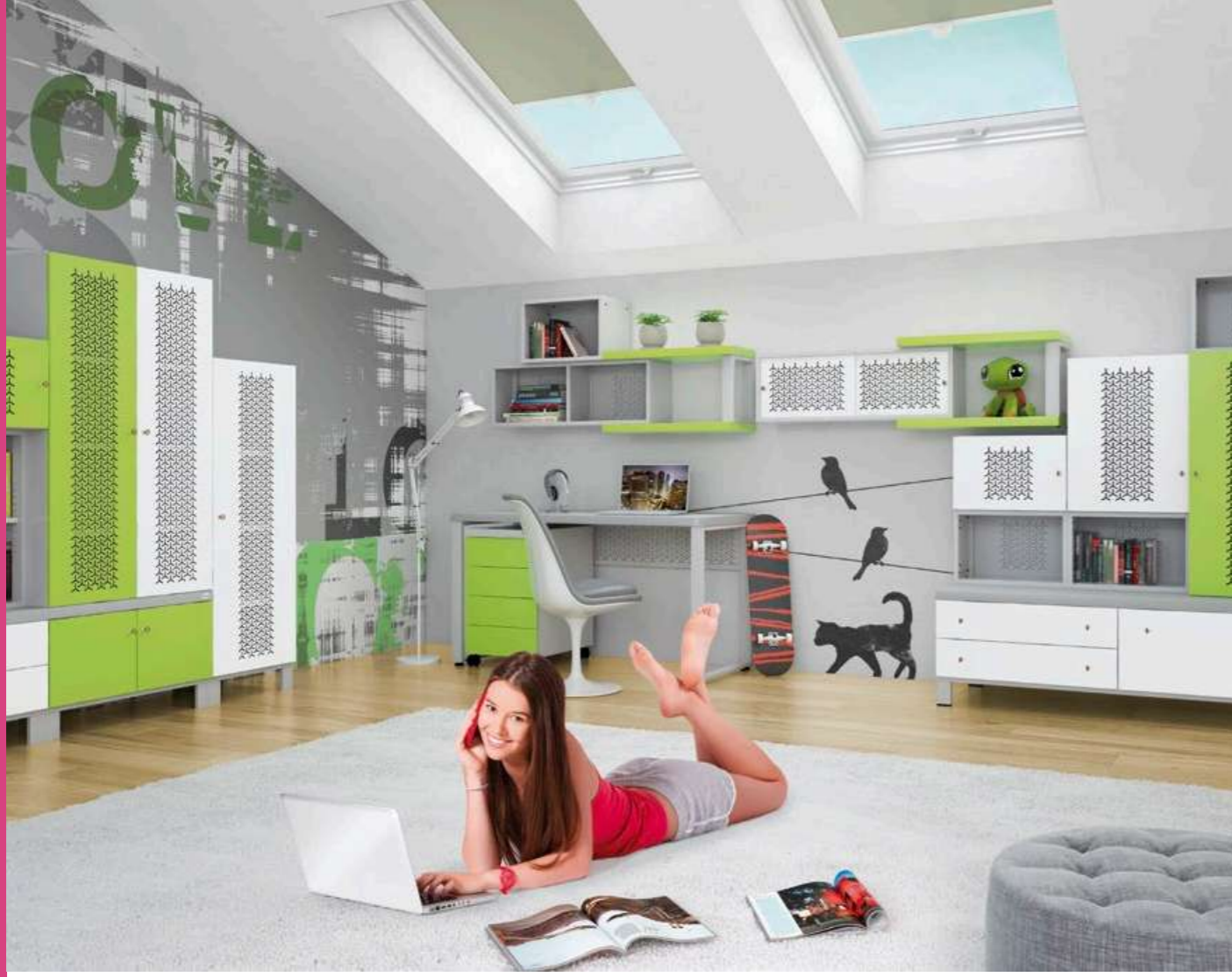

A kitchen made of stainless steel it is not only the highest standards of hygiene, but also the ability to make many of author's ideas of kitchen arrangements. Stainless steel furniture, without toxic paints, adhesives, is also a safety health and life with allergies. A Flat for such persons can be decorated of our metal furniture, reconciling their health requirements with modern and interesting trends in interior design.





Metal office furniture allows for modern, functional and practical equipment of a workplace. Metal optimally meets the requirements in terms of design, quality, functionality and durability. Comfort, functionality, ergonomics – these are the features of metal office furniture which customers appreciate most.



SBM OFFICE CABINETS WITH WING DOORS

- Office cabinets are of comprehensive use thanks to varied possibilities of their internal equipment: adjustable shelves, rich additional equipment (frame drawers, extended shelves, full drawers, equipped cabinet with a compartment).
- Smoothly adjustable shelves (adjustable shelves at full height).
- Available Cabinet with a wardrobe and filing compartment section with a bar with hooks for clothes as well as four shelves for documents.
- In the cabinets for documents there is a door handle equipped with a lock securing in 2 points (the top and the bottom).
- The cabinets are available in various price levels.



Sbm 204





Sbm 203 Primo



Sbm 103 Primo

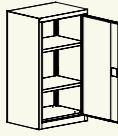
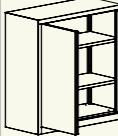
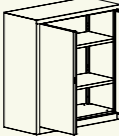
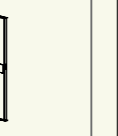
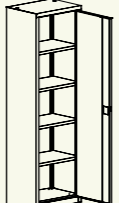
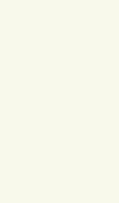
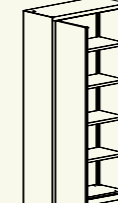

TECHNICAL SPECIFICATION

								
Designation	SBM 101 Primo	SBM 102 Primo	SBM 103 Primo	SBM 107 Primo	SBM 201 Primo	SBM 202 Primo	SBM 203 Primo	SBM 212 Primo
Code	SBM 01023203	SBM 02023303	SBM 03023303	SBM 04023303	SBM 01033204	SBM 02033304	SBM 03033304	SBM 04033304
Height (mm)	1040				1990			
Width (mm)	600	800	1000	1200	600	800	1000	1200
Depth (mm)	435							
Cabinet's capacity	2 rows of binders				5 rows of binders			
Number of shelves	2				4			

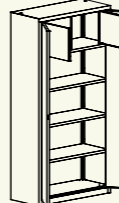
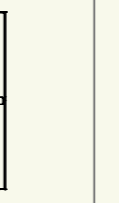
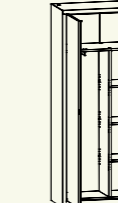
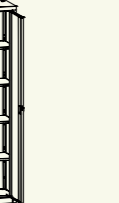
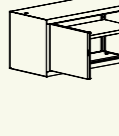
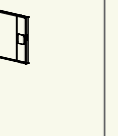
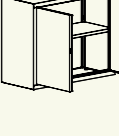
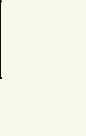
								
Designation	SBM 204 Primo	SBM 213 Primo	SBM 206 Primo	SBM 215 Primo	SBM 403 Primo	SBM 405 Primo	SBM 803 Primo	SBM 804 Primo
Code	SBM 03033305	SBM 04033305	SBM 03033306	SBM 04033306	SBM 03013302	SBM 04013302	SBM 03123302	SBM 04123302
Height (mm)	1990				465			
Width (mm)	1000	1200	1000	1200	1000	1200	1000	1200
Depth (mm)	435							
Cabinet's capacity	4 rows of binders + locker		1 row of binders + 4 in halves		2 low rows		2 rows of binders	
Number of shelves	3		4 shelves + wardrobe compartment		1			

SBM OFFICE CABINETS WITH SHUTTER DOORS

The cabinets with shutter doors are both elegant and functional.

- The doors retract into double side walls of the cabinet made of PVC slats with practical snap lock.
- The cabinet locked with a cylindrical lock.
- In a wardrobe and filing compartment section with a bar with hooks for clothes as well as four shelves for documents.



Sbm 208 Primo

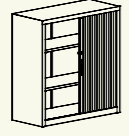
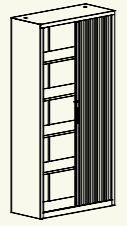
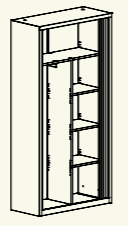
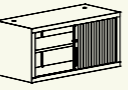

TECHNICAL SPECIFICATION

								
Designation	SBM 105 Primo	SBM 109 Primo	SBM 208 Primo	SBM 217 Primo	SBM 218 Primo	SBM 219 Primo	top cabinet SBM 404 Primo	top cabinet SBM 406 Primo
Code	SBMZ 03023503	SBMZ 04023503	SBMZ 03033504	SBMZ 04033504	SBMZ 03033506	SBMZ 04033506	SBMZ 03013502	SBMZ 04013502
Height (mm)	1040		1990				465	
Width (mm)	1000	1200	1000	1200	1000	1200	1000	1200
Depth (mm)	435							
Cabinet's capacity	2 rows of binders		5 rows of binders		1 row of binders + 4 in halves		2 low rows	
Number of shelves	2		4		4 shelves + wardrobe compartment		1	

AVAILABLE COLOURS OF SHUTTER DOORS

STANDARD



Grey



Cream



Black

EXTRA CHARGE



White



Silver



Beech

SBM OFFICE CABINETS WITH SLIDING DOORS

Office cabinets with sliding doors do not require any additional space to open, and their aesthetic value and reliability are appreciated by their users.

- The cabinets are equipped in 4 adjustable shelves.
- Cabinets are equipped with a cylindrical lock and a door handle.



SBM OFFICE CABINETS WITH RETRACTABLE DOORS

The office cabinet with retractable doors significantly reduces the spaces needed to open the cabinet.

- The doors slide into sides of the cabinet.
- 2-point locking door handle.

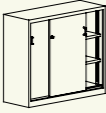
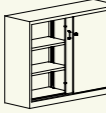
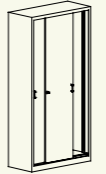
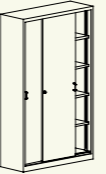
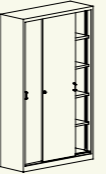
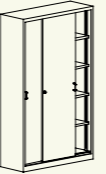

TECHNICAL SPECIFICATION

						
Designation	SBM 112 Primo	SBM 110 Primo	SBM 111 Primo	SBM 222 Primo	SBM 220 Primo	SBM 221 Primo
Code	SBMP 03023603	SBMP 04023603	SBMP 05023604	SBMP 03033604	SBMP 04033604	SBMP 05033620
Height (mm)	1040			1990		
Width (mm)	1000	1200	1400	1000	1200	1400
Depth (mm)	435					
Cabinet's capacity	2 rows of binders			5 rows of binders		
Number of shelves	2	4 (2 shelves on each side of the partition wall)		4	8 (4 shelves on each side of the partition wall)	

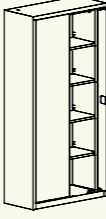
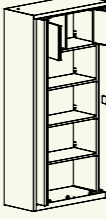
		
Designation	SBM 210 Primo	SBM 211 Primo
Code	SBMC 03033704	SBMC 03033705
Height (mm)	1990	
Width (mm)	1000	
Depth (mm)	435	
Cabinet's capacity	5 rows of binders	4 rows of binders + storage locker
Number of shelves	4	3



ADDITIONAL EQUIPMENT TO OFFICE CABINETS

For office cabinets it is often necessary to have additional equipment: shelves, full drawers, frame shelf. Proposed elements will adjust every wardrobe to the individual needs of users.



full shelf



extended shelf



Full extended drawer



Frame extended drawer for hanging files



Leveling feet

RZ CABINETS WITHOUT DOORS

- Cabinets without doors made of steel with 4 adjustable shelves every 25cm.
- The distance between shelves from the center position : 375mm.
- Maximum load capacity of the standard shelf is : 60kg.







TOWER PEDESTALS AND ADDITIONAL EQUIPMENT

Tower pedestals designed to store the most necessary documents and items allow to keep the workplace clean. Low tower pedestal is an extension of a workplace. High tower pedestal separates workplaces providing discretion, noise reduction and better working conditions.

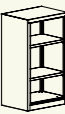
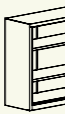

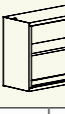
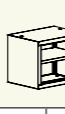
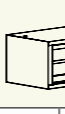
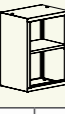
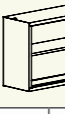
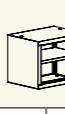
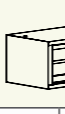
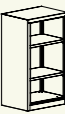
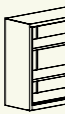
TECHNICAL SPECIFICATION

								
Designation	RZ 101 Primo	RZ 102 Primo	RZ 103 Primo	RZ 107 Primo	RZ 201 Primo	RZ 202 Primo	RZ 203 Primo	RZ 212 Primo
Code								
Height (mm)	1040				1990			
Width (mm)	600	800	1000	1200	600	800	1000	1200
Depth (mm)	435							
Cabinet's capacity	2 rows of binders				5 rows of binders			
Number of shelves	2				4			
TOP CABINETS								
Designation	RZ 801 Primo	RZ 802 Primo	RZ 803 Primo	RZ 804 Primo	RZ 401 Primo	RZ 402 Primo	RZ 403 Primo	RZ 405 Primo
Code								
Height (mm)	810				465			
Width (mm)	600	800	1000	1200	600	800	1000	1200
Depth (mm)	435							
Cabinet's capacity	2 rows of binders				2 low rows			
Number of shelves	1							

Mobile pedestals with upholstered seat allow to store important items and to be used as a seat.

Mediaports with possibility of connecting the most important media directly to sockets placed in a table. It is the possibility of any configuration of necessary slots according to needs. The following slots can be used : the power, computer, telephone, USB and others. Mediaport can be equipped with 2-10 media modules.

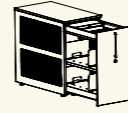
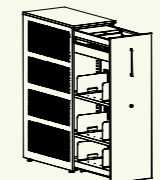
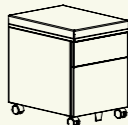
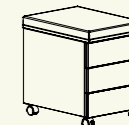

TECHNICAL SPECIFICATION

				
Designation	CB 748	CB 748 P	Szp 522s	Szp 520s
Code	CB 0206061700	CB 0206061706	MSZ 0103010401	MSZ 0103010402
Height (mm)	750		550	
Width (mm)	438		420	
Depth (mm)	800		556	
Equipment	- metal top and front - 1 shelf - 2 small compartments in the top	- melamine top and front - 1 shelf - 2 small compartments in the top	- seat with magnets - metal front - 1 high drawer - 1 low drawer	- seat with magnets - melamine front - 1 high drawer - 1 low drawer

SZK FILING CABINETS

- Filing cabinets are made of steel sheet with a base made of zinc galvanized steel sheet.
- Drawers are installed on double extension ball bearing slides, protected against falling out.
- Cabinets have a special mechanism that allows for opening of only one of the drawers at a time which protects the cabinet against tipping. Drawers are equipped with a central locking mechanism.
- Maximum load capacity of each drawer is 60kg.
- There are self-adhesive cardholders available in relation to the number of drawers.
- Available cabinet in the depth of 435mm (the depth is adjusted to the depth of office cabinets).
- Cabinets are available in various price versions.
- Cabinets are equipped with the shims for leveling.



Skb 210

Skb 310



TECHNICAL SPECIFICATION

Designation	Szk 101	Szk 201	Szk 301	Szk 102	Szk 202	Szk 302	Szk 305	Szk 304	
Code	SZK 01010101	SZK 01020201	SZK 01030301	SZK 02010801	SZK 02020901	SZK 02031001	SZK 02031302	SZK 03031102	
Height (mm)	715	1000	1285	715	1000	1285			
Width (mm)	415			775			545		
Depth (mm)	630								
Quantity of drawers	2	3	4	2	3	4	5		
Quantity of rows in the drawer	1			2			4	2	
Internal dimensions of the drawer (mm)	height x width x depth 244 (front 280) x 330 x 585			height x width x depth 244 (front 280) x 690 x 585			height x width x depth 100 (front 223) x 690 x 585	height x width x depth 187 (front 223) x 460 x 585	
Size	A4						A5 vertical	A5 horizontal	

Designation	Szk 318	Szk 103	Szk 203	Szk 303	Skb 210	Skb 310
Code	SZK 09032102	SZK 02011402	SZK 02021502	SZK 02031602	SKB 101020200525	SKB 0101020100515
Height (mm)	1285	715	1000	1285	940	1225
Width (mm)	610	775			1000	
Depth (mm)	630				435	
Quantity of drawers	5	4	6	8		
Quantity of rows in the drawer	2	4				
Internal dimensions of the drawer (mm)	height x width x depth 150 (front 223) x 522 x 585	height x width x depth 100 (front 137) x 690 x 585			244 (front 280) x 918 x 330	
Size	B5 horizontal	A6				

SRM DRAWING CABINETS

Cabinets for drawings, maps, printing plates and technical documentation that ensure safe, practical and organized storage of these materials. Cabinets are designed for A0/A1 sizes.

- For individual requirements of our customers we are able to divide drawers with additional partitions, into various sizes – from A4 – to A1.
- Maximum load capacity of each drawer is 60kg.
- Drawers are installed on full extension ball bearing slides protected against falling out.
- Central cylinder lock secures all drawers.
- The cabinets can be placed directly on the floor or on the socles.



Optional : drawers' partitions

STB COMFORT OFFICE DESKS

STB COMFORT office desks allow to arrange an office accordingly to individual needs. Both practical and functional, they ensure working in comfort while retaining cohesive style of office spaces.



A rich choice of dimensions, forms and colours will let you find a perfect solution to every office.

SZP Mobile pedestals and additional equipment such as desks connectors and front covers allow for practical furnishing of workplaces and office spaces.

Comfort, functionality, ergonomics – these are features, for which customers value metal office furniture.

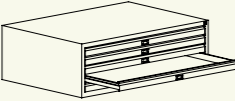
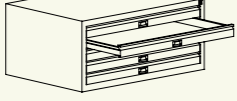
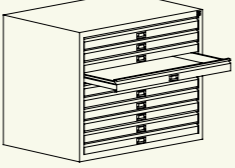

TECHNICAL SPECIFICATION

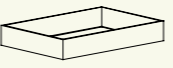
					
Designation	Srm 100	Srm 101	Srm 201	Srm 100 socle	Srm 101, Srm 201 socle
Code	SRM 02010102	SRM 01010102	SRM 01020102	CSRM 0201	CSRM 0101
Height (mm)	425		770	140	
Width (mm)	1315	970		1290	945
Depth (mm)	920	670		895	645
Internal dimensions of the drawer (mm)	height x width x depth 45 x 1235 x 895		height x width x depth 45 x 890 x 630		
Quantity of drawers	5	5	10	-	
Size	A0		A1	A0	A1



■ TECHNICAL SPECIFICATION

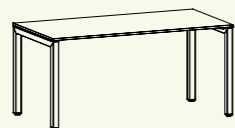

Designation	Stb 1060	Stb 1260	Stb 1460	Stb 1660	Stb 1860
Code	MST 0101010101	MST 0201010101	MST 0301010101	MST 0401010101	MST 0501010101
Height (mm)	745÷770				
Width (mm)	1000	1200	1400	1600	1800
Depth (mm)	600				

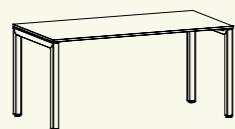

Designation	Stb 1080	Stb 1280	Stb 1480	Stb 1680	Stb 1880
Code	MST 0601010101	MST 0701010101	MST 0801010101	MST 0901010101	MST 1001010101
Height (mm)	745÷770				
Width (mm)	1000	1200	1400	1600	1800
Depth (mm)	800				

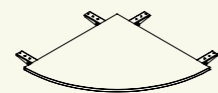
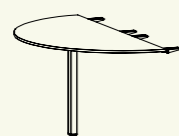
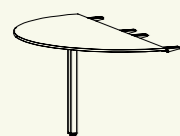

Designation	Half round connector 60	Half round connector 80	Quarter round connector 60	Quarter round connector 80
Code	XMST 02060202	XMST 02070202	XMST 03080202	XMST 03090202
Height (mm)	745÷770			
Width (mm)	1200	1600	600	800
Depth (mm)	600	800	600	800



Designation	Front cover 10	Front cover 12	Front cover 14	Front cover 16	Front cover 18
Code	XMST 01010101	XMST 01020101	XMST 01030101	XMST 01040101	XMST 01050101
Height (mm)	330				
Width (mm)	846	1046	1246	1446	1646





Modern rooms and school classrooms require functional, durable and aesthetic furniture. Such equipment can be found in our offer. To classrooms we recommend the cabinet to storage of tablets and laptops, school desks, cabinets for storage aids. For handy students materials - a popular and practical locker with compartments, to staff rooms – office cabinets for documents. Our cabinets for binders and filing you equip the secretariat and office rooms, the wardrobe lockers – the cloakroom, social lockers – a place of the caretakers and cleaners.

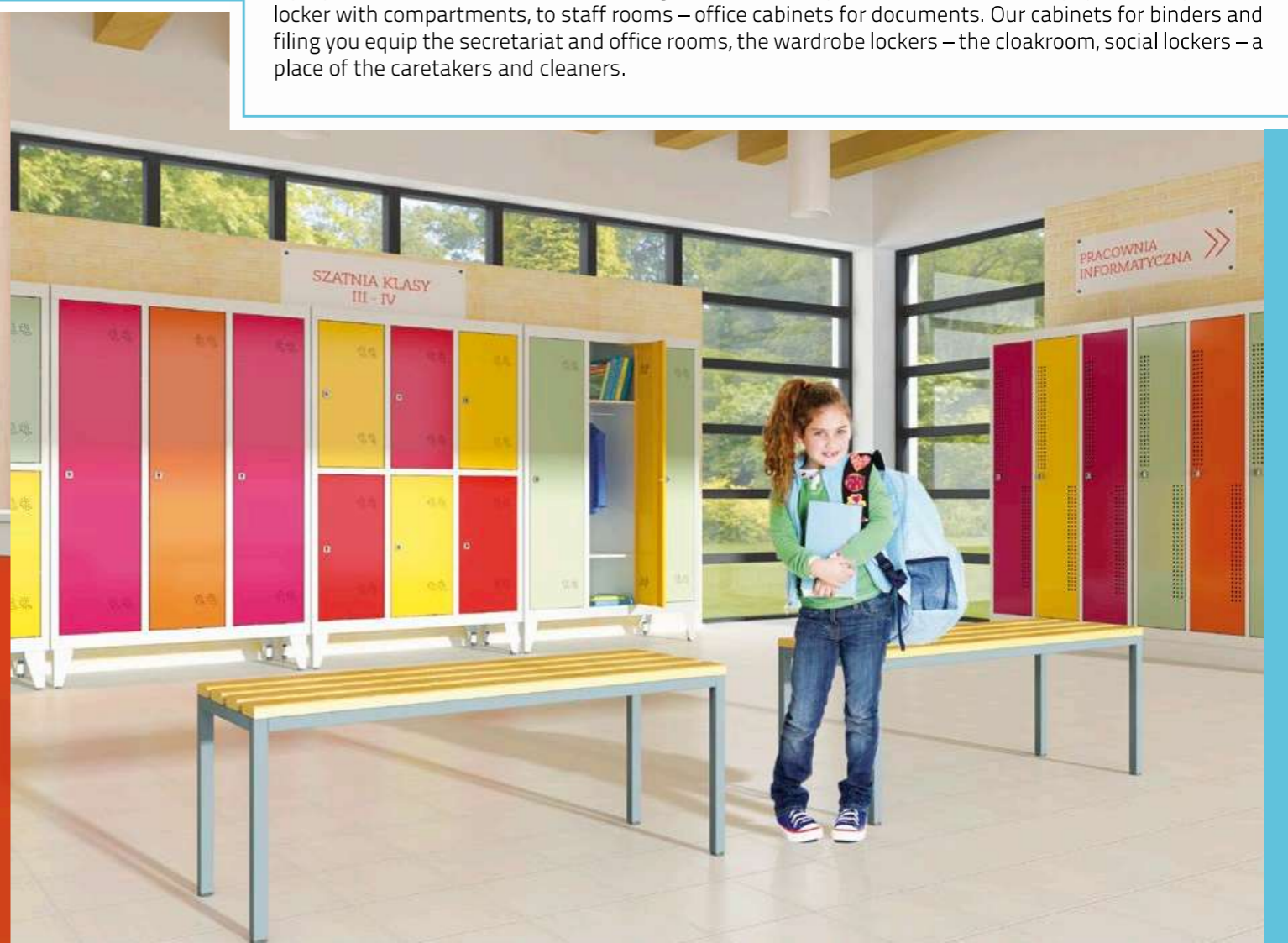
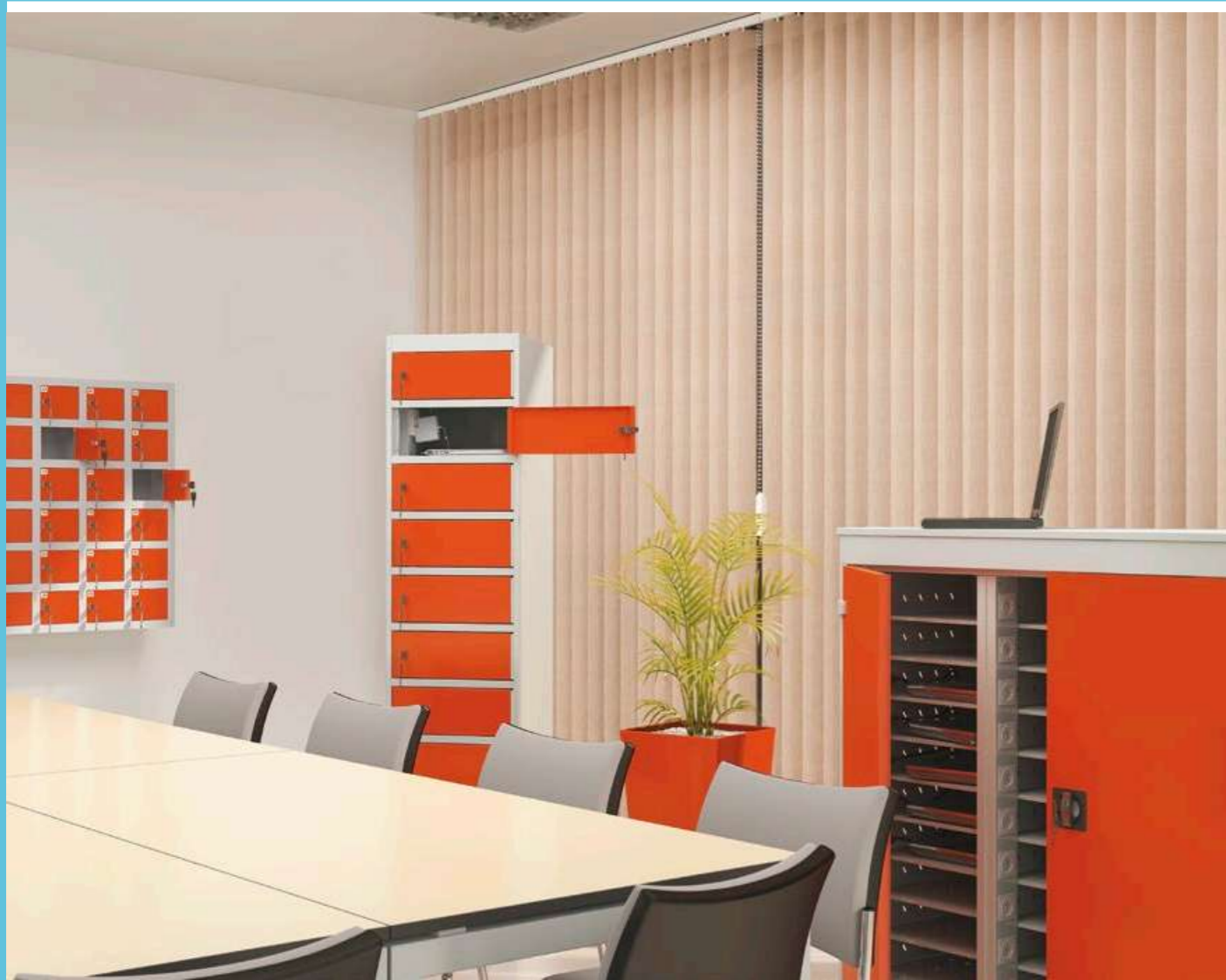

School lockers are made of top quality steel. The bottom of the locker is made of galvanized steel to protect it from corrosion additionally. We use powder coatings from leading global manufacturers. A wide range of standard colours – 16 RAL colours.

SUM S LOCKERS FOR PRE-SCHOOLERS

In our offer we also have 1350 mm high SUM S lockers. Even the youngest children will be able to hang their clothes and reach the shelves without any effort. Cloakrooms in kindergarten equipped with wardrobe lockers enhance kinds' independence. Children who have their own individual lockers more willingly and actively prepare to their classes.

SUM S LOCKERS FOR 6-YEAR-OLDS



For younger pupils we offer lockers height of 1500 mm. In the compartments of the lockers the ventilation holes are made allowing free exchange of air.

Additional equipment:

- The bar with hooks
- The shelf for books, notebooks and handheld things.

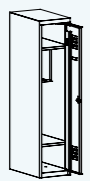
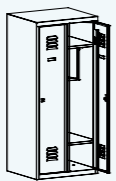
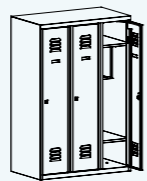

TECHNICAL SPECIFICATION

				
Designation	SumS 310p	SumS 320p	SumS 330p	SumS 340p
Code	SUM 1703040112	SUM 1803040112	SUM 1903040112	SUM 2003040112
Height (mm)	1350			
Width (mm)	300	600	900	1200
Depth (mm)	500			
Number of units	1	2	3	4

TECHNICAL SPECIFICATION

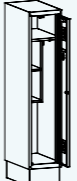
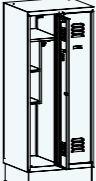
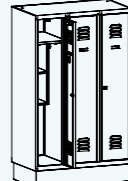
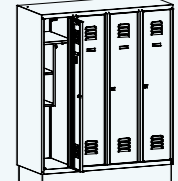
				
Designation	SumS 310	SumS 320	SumS 330	SumS 340
Code	SUM 1702020510	SUM 1802020510	SUM 1902020510	SUM 2002020510
Height (mm)	1500			
Width (mm)	300	600	900	1200
Depth (mm)	500		500	
Number of units	1	2	3	4

WNT TABLET TROLLEY

Tablet trolley has inbuilt battery charge function and is designed to store and carry 32 tablets and one laptop. It is a perfect solution for schools, libraries, meeting rooms, in other words in every place that safe storage and simultaneous tablet recharge is needed.

WNT tablet trolley advantages:

- Simultaneous recharge of up to 32 units of such devices as : tablets, smartphones, and one laptop.
- Each USB socket is equipped with LED diode confirming its correctness of the work.
- Both circuit-breaker protection and protection against overload.
- Protection against overheating.
- Implementation of single loading time limiter (up to 5 hours) to safe batteries of currently charging devices and to decrease energy consumption.

*Contact us to know what devices can be charged in our trolleys.



WNL LAPTOP TROLLEY

- The WNL Laptop trolley is meant to store laptops and to provide battery recharge function.
- We have applied a sequencer to provide overload and surge protection, which allow to enable individual terminal blocks after a particular period of time (~3 minutes). That results in maintaining low electrical load of the trolley.
- Flashing diode signals the state of work of particular terminal blocks
- The trolley has one connector plug and overload fuse.
- The trolley is also equipped on both sides with grips, the top is made from melamine, ventilation holes for air circulation and with 4 wheels (2 of them are with a brake).
- Additionally, side edges of the trolley are secured with rubber corners.



LAPTOP LOCKER

Cabinet is used to protect PC units with the simultaneous possibility of recharging the battery during storage. Inside the body, on the side the strip is mounted which contains sockets for connecting chargers, laptops - in every locker.

Designation	Locker for laptops SZNL 4110		WNL 110	WNL 208	WNL 210	WNL 213	WNL 310	WNT 33
Code	SZNL 0101010101	SZNL 0101010104	WNL 0514060204	WNL 0615050404	WNL 0614050404	WNL 0616050404	WNL 0714050404	WNL0917050604
Height (mm)	1800		1250	1060	1250	1540	1250	1050
Width (mm)	400		530	920			1310	730
Depth (mm)			500					440
Description	Locker without wiring	Locker with wiring	1 column 10 sockets (10 laptops)	2 columns 8 sockets (16 laptops)	2 columns 20 sockets (20 laptops)	2 columns 13 sockets (26 laptops)	3 columns 10 sockets (30 laptops)	the trolley to storage 32 tablets + 1 laptop

MOBILE PHONE LOCKER

The locker for storing mobile phones for places where their use is forbidden. Lockers provide a safe storage space for places such as reading rooms, libraries, gyms, schools. Each compartment has its own, independent lock. There is a possibility to mount code or coin locks.

Designation	WSS 5	WSS 10	WSS 20	WSS 30	WSS 35
Code	WSS 06010601	WSS 01010101	WSS 02010201	WSS 03020301	WSS 07010701
Height (mm)		780		930	780
Width (mm)	210	390	750	930	1290
Depth (mm)	200				

Designation	WSS 50	WSS 55	WSS 60	WSS 80	WSS 90
Code	WSS 03030801	WSS 03040901	WSS 04030401	WSS 05030501	WSS 08031001
Height (mm)	1530	1680		1530	
Width (mm)	930		1110	1470	1650
Depth (mm)	200				

SOCIAL FURNITURE



Metal social furniture guarantee both functionality and aesthetics of the social rooms in factories, schools, gyms, fitness clubs, swimming pools, military rooms, etc. The proper arranging of such rooms, taking into account the most diverse requirements and needs, ensures well-being and raises the standard of workplace learning.



SUM W WARDROBE LOCKERS

- All lockers are manufactured from steel sheet. There is a possibility to produce lockers made of various kind of metal sheets (stainless, galvanized, acid proof).
- Lockers are powder coated.
- We offer lockers in various price versions – depending on the type of the sheet and its thickness.
- Doors have the ventilation holes which allow exchange of the air between the locker and the room.

LOCKERS – SHEET TYPES

- Steel + powder coated
- Galvanized + powder coated = additional protection against corrosion
- Acid-proof = additional protection against corrosion



Sum 420 W



Sum 321



Sum 420+P 421



Sum 421k



TECHNICAL SPECIFICATION

300mm wide without partition wall					
	Designation	Sum 310 W	Sum 320 W	Sum 330 W	Sum 340 W
	Code	WSU 0101020102	WSU 0102020102	WSU 0103020102	WSU 0104020102
	Height (mm)	1800			
	Width (mm)	300	600	900	1200
	Depth (mm)	500			
Number of units	1	2	3	4	

400 mm wide lockers with an internal partition wall				
	Designation	Sum 410 W	Sum 420 W	Sum 430 W
	Code	WSU 0201020103	WSU 0202020103	WSU 0203020103
	Height (mm)	1800		
	Width (mm)	400	800	1200
	Depth (mm)	500		
Number of units	1	2	3	

SUS W WARDROBE LOCKERS

- Locker with compartments, due to their functionality, diversity and aesthetic appearance can be used in cloakrooms, kindergartens, schools, swimming pools, fitness clubs, railway stations for keeping luggage, in supermarket, at work place for keeping bags and helmets, etc.
- Ventilation slots in the doors allow exchange of air in the locker.
- Locker with compartments are available in various price versions – depending on the steel sheet type and its thickness.



TYPES OF LOCKS:

- As options Euro-lock type key lock (C) or a padlock for hanging locks can be used (D).
- There is a possibility to order lockers with the MASTER key (one key can open particular number of locks).
- Other available (for an additional charge) locks:
 - water-resistant cylindrical locks (a brass insert and a key)
 - coin locks (E) – with return (F) and without return (G)
 - code locks and others – on customer's request.

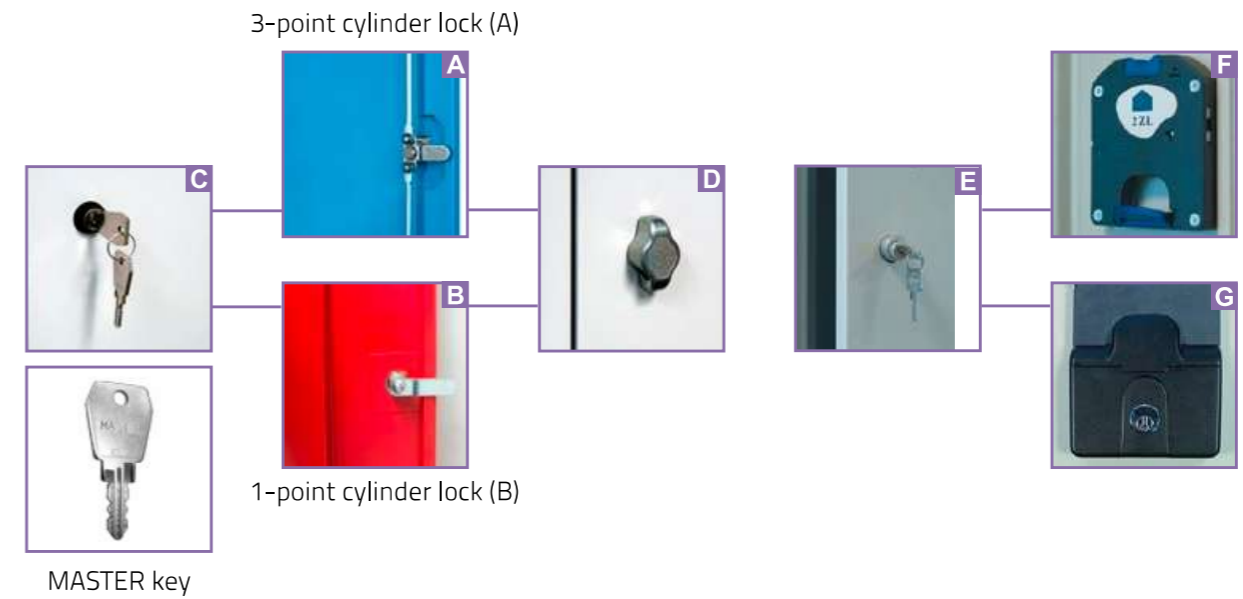

ADDITIONAL EQUIPMENT :

- a plastic bar with hokks
- a shelf above the bar
- inner partition (in the column width of 400 mm)
- a mirror
- a hanger
- lockers may have slanted tops that facilitate cleanliness



TECHNICAL SPECIFICATION

Designation	SUS 322 W	SUS 324 W	SUS 325 W
Code	WSU 0107020104	WSU 0117020101	WSU 0122020101
Height (mm)	1800		
Width (mm)	600		
Depth (mm)	500		
Number of units	2		



slanted top



WSU cocker socle, to be screwed to the locker (140 mm high)



base frame with legs for WSU locker (140 mm high)



base with a bench with adjustable feet



base with bench with adjustable feet



base with bench with adjustable feet – economic version



base with extendable bench with adjustable feet



base with a bench with adjustable feet – economic version

SUL W WARDROBE LOCKERS

- In order to make use of small spaces such as cloakrooms, made the L-shape wardrobe locker.
- Lockers are manufactured as single or double units. They can be placed on the wardrobe lockers.
- We offer lockers in various price versions, depending on the steel sheet type and its thickness.
- 1-point lock as a standard.



CANTEEN LOCKERS

Canteen lockers to store food and personal items are ideal choice in dining areas, buffets and canteens.

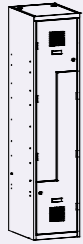
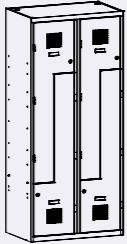

TECHNICAL SPECIFICATION

		
Designation	SUL 41 W	SUL 42 W
Code	WSU 0406030104	WSU 0407030104
Height (mm)	1800	
Width (mm)	400	800
Depth (mm)	500	
Quantity of doors	2	4



SUL 42 W

TECHNICAL SPECIFICATION

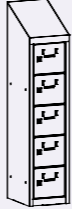
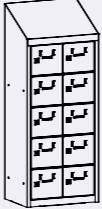
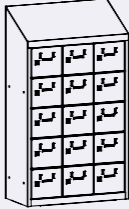
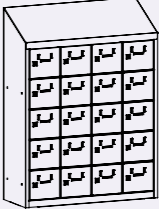
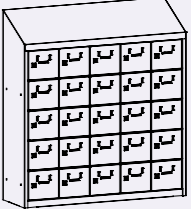
					
Designation	SUS 215W	SUS 225W	SUS 235W	SUS 245W	SUS 255W
Code	SUS 0821050601	SUS 0822050601	SUS 0823050601	SUS 0824050601	SUS 0825050601
Height (mm)	1090				
Width (mm)	240	430	620	810	1000
Depth (mm)	300				
Quantity of doors	5	10	15	20	25

SMD CABINETS FOR CLEANING STAFF

Multifunctional cabinets are designed for administrative and cleaning purposes. The equipment of the cabinets allows keeping clothes, cleaning products, buckets, brushes, etc. Adjustable shelves.



LOCKER FOR DRYING CLOTHES

Wardrobe lockers with heating and ventilation for drying clothes is a very practical and modern specialist equipment. Heated clothes drying lockers are designed to dry wet clothes, shoes and gloves in closed rooms. This is a perfect solution wherever environmental conditions cause dampness. They are i.e. construction sites, airports, mines, and many other.

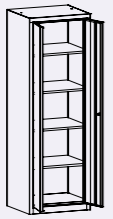
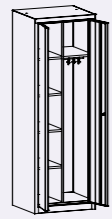
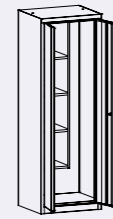

TECHNICAL SPECIFICATION

			
Designation	SMD 60	SMD 61	SMD 62
Code	SAU 0401030201	SAU 0401030401	SAU 0401030501
Height (mm)	1800		
Width (mm)	600		
Depth (mm)	500		
Equipment	4 shelves	- compartment with shelves - compartment with a shelf and a bar for clothes	- compartment with shelves - compartment for keeping brushes, mops and a bucket







SMD 60

SMD 61

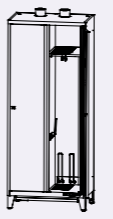
SMD 62

TECHNICAL SPECIFICATION

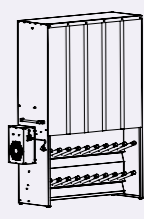
					
Designation	SUM 421	SUM 421	SUM 421	SUM 421	Cabinet for clothes and shoes' drying
Code	SUMW 0701030214	SUMW 0701030215	SUMW 0701030219	SUMW 0701030230	XXP 020055
Height (mm)	2006				
Width (mm)	800				
Depth (mm)	490				
Equipment	- ventilation and heating 1000 W	- ventilation and heating 1000 W, - internal partitions in compartments	- ventilation and heating 1000 W, - internal partitions in compartments, - a time switch, - power socket to link 3 lockers	- ventilation, - power socket to link 3 lockers	- a bar for clothes, - 20 pipes for shoes, - 2 heating and ventilation modules, - 2 handles to move the cabinet, - leveling feet

KBS LOCKERS

- The common frame allows opening all compartments at the same time and placing clean gloves for each worker at one time, then each worker opens his compartment and takes his gloves out.
- The module of the locker also contains the compartment for hanging bag for dirty clothes.



METAL RECYCLING BIN

Bins for in-door use, to separate wastes: plastic, paper, glass. Body is made of powder-coated steel sheet. Slanted top prevent wastes from building-up on top of the bin. Self-closing lids prevent precipitation of smell.



TECHNICAL SPECIFICATION

Designation	KBS 1	KBS 2	KBS 3	KBS 4
Code	KBS 01050201	KBS 03050601	KBS 02050201	KBS 04050601
Height (mm)	1900			
Width (mm)	1225	820	840	435
Depth (mm)	500			
Quantity of compartments	22 + chamber	22	11 + chamber	11



KBS 3

TECHNICAL SPECIFICATION

Designation	MPO 01r	MPO 01k	MPO 02r	MPO 02k	MPO 02rk	MPO 03r	MPO 03k	MPO 03rrk	MPO 03kk
Code	PNO 0101010301	PNO 0101010201	PNO 0201010301	PNO 0201010201	PNO 0201010401	PNO 0301010301	PNO 0301010201	PNO 0301010601	PNO 0301010501
Height (mm)	1220								
Width (mm)	400		800			1200			
Depth (mm)	450								
Equipment	1 extendable frame	1 bin	2 extendable frames	2 bins	1 extendable frame + 1 bin	3 extendable frames	3 bins	2 extendable frame + 1 bin	2 bins + 1 extendable frame



We offer a full arrangement for doctor's office. From our furniture you can arrange an appealing and functional doctor's room. This is, of course, only one of our suggestions as the final decision rests on you.

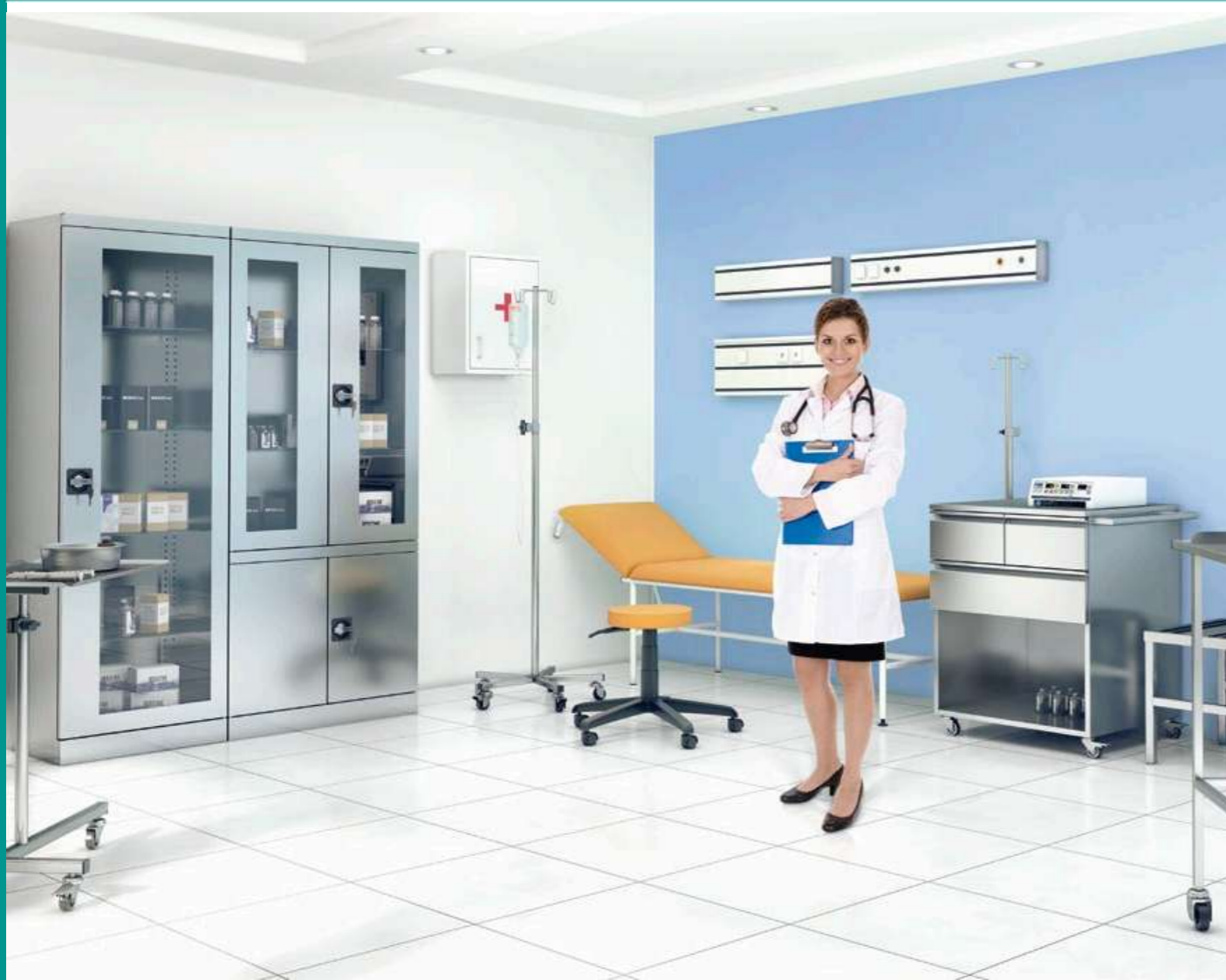

MEDICAL DESK

A small, practical doctor's desk. A Container of the desk is constructed with two drawers adapted to the format of card disease patients.



SML CABINETS FOR DOCTORS

- Cabinet doors are made of safety glass – of tempered glass, glass shelves – adjustable every 25 mm.
- There is a possibility to produce lockers on castors which allow for easy movement.



TECHNICAL SPECIFICATION

Designation	Bim 212s	Zbm 304
Code	BIML 01021420	STBJ 16020705
Height (mm)	740-770	740
Width (mm)	1200	1800
Depth (mm)	600	800



Designation	Sml 101	Sml 111	Sml 102	Sml 112
Code	SML 0101020101	SML 0101020102	SML 0201030102	SML 0201030101
Height (mm)	1800	1890	1890	1800
Width (mm)	600		800	
Depth (mm)	435			
Number of shelves	4			
Quantity of doors	1		2	
Wheels	-	+	+	-

TECHNICAL SPECIFICATION



Designation	Sml 103	Sml 113	Sml 104	Sml 114	Sml 105	Sml 115
Code	SML 0301030101	SML 0301030102	SML 0201050402	SML 0201050401	SML 0201030702	SML 0201030701
Height (mm)	1800	1890	1890	1800	1890	1800
Width (mm)	1000	1000	800	800	800	800
Depth (mm)	435					
Number of shelves	4		2 + compartment			4
Quantity of doors	2		2 + 2 doors compartments			2
Wheels	-	+	+	-	+	-

MOVABLE SHELVING SYSTEM



LITREG system of movable rack was designed for libraries and archives. This is a perfect solution for archiving purposes providing great possibilities. Our system allows maximal usage of available storage place and and to archive documents. We have also movable racks for clothes. We also recommend our SOFT TOUCH electric drive rack system. This is a truly innovative solution for archivization. The process of operating the racks is effortless. After pressing the button the racks are moving automatically so as to grant access to required catalogues.





Furniture made of stainless and acid proof steel manufactured by MALOW allow comprehensive furnishing of gastronomic places with:

- modular work tables, which allows creating a table matched to customer's request.
- work tables with sinks,
- overshelves,
- corner tables,
- tabletops,
- wall cabinets,
- wall mounted shelves,
- cabinets with wing or sliding doors (including through cabinets),
- racks on feet or on wheels, with shelves or with perforated shelves,
- hoods and service trolleys.





During the design and manufacturing process, we care about all the details: order, safety, versatility, functionality, ergonomics, design and most importantly - people and their needs at the workstation.

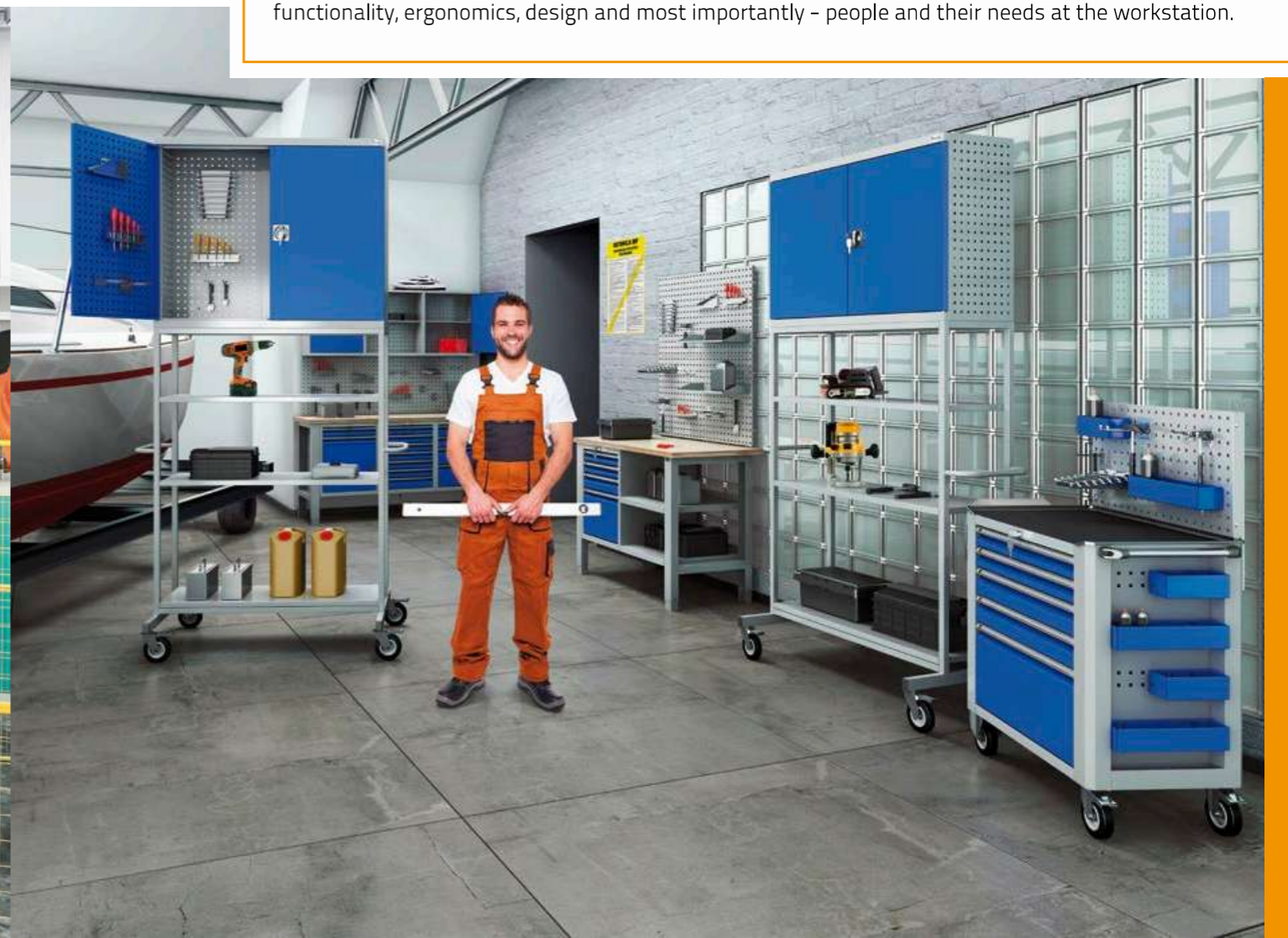

SMK INDUSTRIAL COMPUTER CABINET

- The top part of the cabinet allows using the computer even in the presence of dust and dirt in the air.
- The lower, covered part, serves for safekeeping of other peripherals.
- An extendable shelf allows use of computer keyboard (in basic version the shelf is fixed).
- It is also available to equip the cabinet with an internal electrical fan that cools the monitor. In the bottom part of the cabinet a surge suppression strip can be mounted.
- The back wall has ventilation holes in it. The adjustable shelf makes it possible to set its height in dependence on the kind of computer being kept in the cabinet (in basic version the shelf is fixed).



SPNK INDUSTRIAL COMPUTER CABINET

- Flat case of minimal depth.
- Front screen adapted for LCD monitor of 16:9 aspect ratio and diagonal – up to 22 inches.
- IP-42 protection class, supported with researches: protection from objects larger than 1 mm and protection from drops of water falling on the case at 15°.
- Removable bottom allows screwing the cabinet directly to the ground.
- As a standard the cabinet is equipped with: a fan, main supply cable, Ethernet loop and surge suppression strip.



SPNK



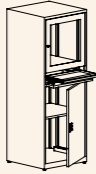
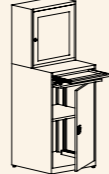

TECHNICAL SPECIFICATION

						
Designation	SmK	SmKa	SmK1	SmK1a	SmK 4a	SmK 4a
Code	SMK 0101010201	SMK 0101010202	SMK 0101010101	SMK 0101010102	SMK 0101010105	SMK 0101010205
Height (mm)	1750					
Width (mm)	640					
Depth (mm)	630					
Equipment	-The keyboard protecting part opens together with the main doors. The cabinet with equipment: a fan and a power strip	- The keyboard protecting part opens separately. The cabinet with equipment: a fan and a power strip	- The keyboard protecting part opens together with the main door. The cabinet without any additional equipment – without fan and power strip	- The keyboard protecting part opens separately. The cabinet without any additional equipment – without fan and power strip.	- the keyboard protecting part - adjustable shelf	- the keyboard protecting part - adjustable shelf - a fan - a power strip

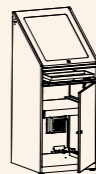
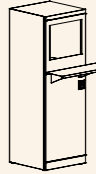

SmK 2

				
Designation	SmK 3A	SmK 3A	SmK 2	SPNK
Code	SMK 0405010104	SMK 0405010204	SMK 0202030203	SMK0506050506
Height (mm)	1545		1600	1770
Width (mm)	640		550	755
Depth (mm)	635		550	330
Equipment	The cabinet without electrical equipment. Equipped with: - a drawer for a keyboard - extendable shelf in the lower compartment - ventilation on sides - holes in the rear side for supply cables	The cabinet with electrical equipment. Equipped with: - a drawer for a keyboard - extendable shelf in the lower compartment - ventilation on sides - holes in the rear side for supply cables	The cabinet equipped with a shelf (for a keyboard and a mouse) fixed (montage at client's place), a fan and a power strip with 4 sockets	Cabinet equipped with: - a fan, - a power strip, - a terminal, - a power strip with the anti-interference filter.

SBM W WORKSHOP CABINETS

From our selection of workshop cabinets everyone can find the right cabinet for one's workshop and for every kind of equipment. Extremely durable and practical metal workshop cabinets can be used in all conditions. It is possible to adjust shelves to any height due to mounting holes punched with 25 mm interspaces. Door handle is equipped with a two point blocking lock.



SZWN WORKSHOP CABINET ON WHEELS

Workshop cabinets on wheels are equipped with:

- hardwood plywood top
- central locks blocking all drawers
- drawers mounted on sliding bearing guides (maximum

loading capacity is 30 kg)



- cupboard doors locked with cylindrical locks
- two manoeuvrable wheels



WORKSHOP CABINET WITH BOXES

Helps to keep small items in order. These objects are locked, on place and always at hand, what is comfortable in warehouses, workshops and stores.

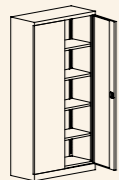
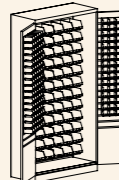
TECHNICAL SPECIFICATION

			
Designation	Sbm 203W	Sbm 212W	Swm 205
Code	SBM 03030304	SBM 04030304	SWM 0202030402
Height (mm)	1990		
Width (mm)	1000	1200	1000
Depth (mm)	435		
Equipment	Quantity of shelves 4		Quantity of boxes small: 80 pcs on every door large: 72 pcs on the back wall Dimensions of boxes (mm) small: 56 x 77 x 119/90 large: 108 x 144 x 224/170



Swm 205

TECHNICAL SPECIFICATION

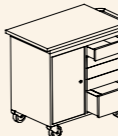
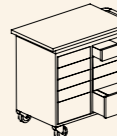
		
Designation	SzWN 251	SzWN 252
Code	GWJ 0101020702	GWJ 0101010802
Height (mm)	928	
Width (mm)	961	
Depth (mm)	600	
Equipment	5 drawers including a deep one	10 drawers including 2 deep ones



SzWN 251

RMM STORAGE RACKS

- Universal storage racks necessary in those places, where different items, tools, cardboard boxes, and other items are kept. In order to shorten the time-consuming montage we have come up with racks that do not need screws to be assembled. They are very easy and smooth to assembly and disassembly. Durability, solidity and quality are real advantages of these racks. Elements are made of powder coated steel sheet. Possible to produce – on customer’s demand - racks made of galvanized or acid proof steel sheet are also available.
- In the storage rack the shelves are adjustable with 60 mm interspaces, and in snap-together racks – with 30 mm interspaces. Maximum loading capacity of the shelf is 100 kg.



TECHNO WORKBENCHES

- Thanks to its modular construction and two lines we offer you a possibility of creating any possible configuration adjusted to specified needs:
- Heavy TECHNO EXPERT workbenches is designed for professional solutions (maximum loading capacity is 1350 kg).
 - TECHNO LIGHT workbenches is designed for professional as well as for amateurish solutions (maximum loading capacity is 600 kg).

TECHNO EXPERT



TECHNICAL SPECIFICATION

	Rmm 302	Rmm 301	Rmm 303	Rmm 202	Rmm 201
Designation	Rmm 302	Rmm 301	Rmm 303	Rmm 202	Rmm 201
Code	RMM 0301010201	RMM 0303040201	RMM 0305030201	RMM 0102020101	RMM0204030101
Height (mm)	900	1980	1800	1510	2000
Width (mm)	1000	1000	1000	750	900
Depth (mm)	500	500	500	300	600
Number of shelves	3	6	5	4	5
Assembly with screws				+	+
Assembly without screws	+	+	+		
Load capacity (kg)	200	200	200	100	100



Rmm 301

TECHNO LIGHT



WWT WORKSHOP TROLLEY

Professional line of Techno workshop trolley, thanks to its functionality, is a perfect solution for garages, service stations and facilities. Additional accessories such as: perforated wall, containers, drawers dividers, microrubber, tool hangers, make our workshop trolleys a movable work stations.



STANDARD RAL COLOURS



RAL 9010



RAL 1015



RAL 7032



RAL 8016



RAL 1023



RAL 2004

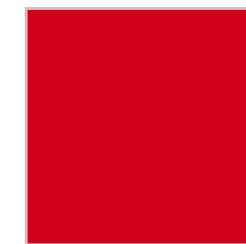

RAL 3020

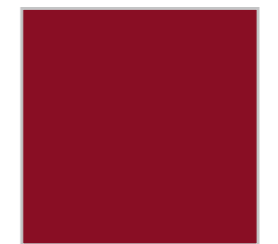

RAL 3005

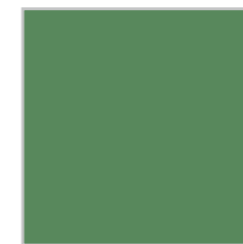

RAL 6011



RAL 6033



RAL 5018

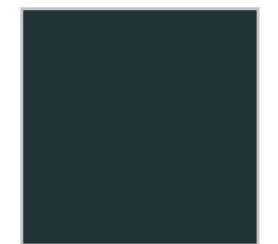

RAL 7016



RAL 5012



RAL 5010





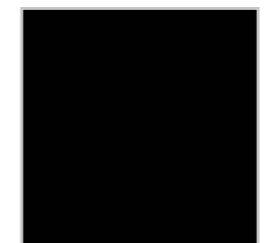

RAL 7035



RAL 9005

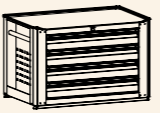

TECHNICAL SPECIFICATION

					
Designation	WWT 75A	WWT 75B	WWT 75C	WWT 75D	top box for WWT trolley
Code	WWT 0101010102	WWT 0101010202	WWT 0101010302	WWT 0101020401	XXXP 030042
Height (mm)	900				516
Width (mm)	790				
Depth (mm)	490				
Equipment	1x drawer 300 mm 2x drawer 100 mm 2x drawer 75 mm	1x drawer 200 mm 1x drawer 150 mm 4x drawer 75 mm	1x drawer 200 mm 6x drawer 75 mm	Hinged door 2 adjustable shelves	4 x drawer 100 mm

The only purpose of this table is to show the colours roughly. For more accurate view please see full RAL colours palette. We reserve the right to possibility of occurring insignificant differences from the given colours, what should not be a reason of any complaints.

We also reserve the right to implement construction changes in our production, what can have insignificant influence on the product appearance.

Colours of products shown in the photographs in the catalogue and the visualisations have demonstrative character only and may differ from the colours of the offered products.



MALOW Spółka z o.o.

ul. Wojska Polskiego 114 A
16-400 Suwałki
POLAND
www.malow.pl
marketing@malow.com.pl
tel. +48 87-56607 44, 42
fax +48 87-56607 27



Category : INVESTMENT



The Podlaskie voivodeship