

Caimi
BREVETTI

SNOWSOUND



Snowsound

Index

Snowsound Technology

	pg.22				
Giotto design Sezgin Aksu	pg.34	Flap design Alberto Meda, Francesco Meda	pg.52	Snowfront design Caimi Lab	pg.86
Giotto lux design Sezgin Aksu	pg.36	Baffle design Marc Sadler	pg.62	Oversize desk design Caimi Lab	pg.88
Snowfix design Caimi Lab	pg.38	Baffle Oversize design Marc Sadler	pg.64	Design Collection design Caimi Lab	pg.90
Oversize design Caimi Lab	pg.40	Tra design Marc Sadler	pg.66	Snowsound Art design Gillo Dorfles	pg.96
Oversize lux design Marc Sadler	pg.42	Mitesco design Michele De Lucchi	pg.68	Blade design Lorenzo Damiani	pg.100
Pli Oversize design Marc Sadler	pg.46	Corner design Marc Sadler	pg.82	Corista design Lorenzo Palmeri	pg.102
Pli design Marc Sadler	pg.50	Pli desk design Marc Sadler	pg.84	In design Caimi Lab	pg.104

Snowsound Fiber Products

pg.106

Diesis
design Atelier Mendini

pg.110

Bemolle
design Atelier Mendini

pg.110

Sipario
design Alberto Meda,
Francesco Meda

pg.114

Palio
design Sezgin Aksu

pg.116

Si Sboccia
design Moreno Ferrari

pg.118

Snowsound Extra

pg.122

Snowsofa
design Sezgin Aksu

pg.122

Cocker
design Caimi Lab

pg.126

Snowall
design Caimi Lab

pg.128

Snowsound Fiber Textiles

pg.130

Projects

pg.132

Office pg.134

Public spaces & Museums pg.174

Education & Schools pg.190

Retail & Leisure pg.200

Restaurants, Cafès & Hotels pg.206

Home pg.234

Audio & Music pg.240

Caimi Brevetti

I Fondata nel 1949 Caimi Brevetti S.p.A. è una delle principali realtà produttive europee design-oriented nel settore dell'arredamento e dei complementi d'arredo per l'ufficio ed il contract. Dire Caimi Brevetti è dire sperimentazione di nuovi materiali e nuove tecnologie industriali, con l'occhio rivolto non solo ad una migliorata produttività, ma anche all'ottenimento di un sempre minor impatto sull'ambiente ottenuto con lavorazioni meno inquinanti e l'utilizzo di materiali riciclati e riciclabili. In quest'ottica i sistemi di pannelli acustici brevettati e le tecnologie brevettate Snowsound sintetizzano design, elevate prestazioni tecniche e funzionalità, il tutto concepito nel più rigoroso rispetto dell'ambiente. Le molteplici iniziative di Caimi Brevetti nel settore del design e della cultura hanno portato all'esposizione dei suoi prodotti presso mostre e musei e l'hanno vista protagonista di importanti riconoscimenti, tra i quali due premi Compasso d'Oro ADI e il premio DesignEuropa Awards, assegnato dall' Ufficio dell'Unione Europea per la proprietà intellettuale (EUIPO).

EN Founded in 1949, Caimi Brevetti S.p.A. is one of the main design-oriented production realities in Europe in the sector of furniture and furnishings for the office and contract. To say Caimi Brevetti is to say experimentation with new materials and new industrial technologies with an eye turned not only toward improved productivity, but also to obtaining an ever minor impact on the environment as a result of workings producing less pollution and using recycled and recyclable materials. In this context, the patented acoustic panels systems and the Snowsound patented technologies are joined to synthesize design, improve technical and functional performance, all conceived with the utmost respect for the environment. The multiplicity of initiatives of Caimi Brevetti in the fields of design and culture has carried it to the exposition of its products at exhibitions and in museums and led it to take a leading position receiving major awards, including two ADI Premio Compasso d'Oro and the DesignEuropa Awards by EUIPO (European Union Intellectual Property Office).

Since 1949



Compasso d'Oro
2008



Compasso d'Oro
2016



DesignEuropa Awards
by EUIPO (European
Union Intellectual
Property Office)



Made in Italy

F Fondée en 1949 Caimi Brevetti S.p.A. est une des plus importantes sociétés de production orientées au design dans le secteur de l'ameublement et des compléments et accessoires d'ameublement pour bureau et contract. Caimi Brevetti signifie essai de nouveaux matériaux et nouvelles technologies industrielles, non seulement en cherchant toujours à améliorer la production mais aussi à garantir le plus bas impact sur l'environnement possible à travers des usinages moins polluants et l'emploi des matériaux recyclés et recyclables. Dans ce cadre les systèmes de panneaux acoustiques brevetés et les technologies brevetées Snowsound, synthétisent design, des prestations techniques et des fonctions de haut de gamme, dans le plus rigoureux respect de l'environnement. La majorité des initiatives de Caimi Brevetti dans le secteur design et culture a permis de présenter ses produits à l'occasion d'exhibitions et dans des musées. Il faut aussi rappeler que la société a été assignée un grand nombre de reconnaissances au niveau international, deux prix en particulier, le Compasso d'Oro ADI et le prix DesignEuropa Awards, attribué par l'Office de l'Union Européenne pour la Propriété Intellectuelle (EUIPO).

D Das Unternehmen Caimi Brevetti S.p.A wurde im Jahr 1949 gegründet und gehört zu den wichtigsten europäischen Herstellern von designorientierten Produkten für Büro- und Objekt. Der Name Caimi Brevetti steht für die Entwicklung neuer Materialien und Technologien. Umweltschutz durch umweltfreundliche Produktionsmethoden hat oberste Priorität. Die Verwendung wiederverwerteter und wiederverwertbarer Materialien ist ein Kennzeichen der Produkte von Caimi Brevetti. Unter diesen Aspekten wurden die patentierte schallabsorbierende Paneele und die patentierte Snowsound Technologien entwickelt. Design, hohe technische und funktionelle Leistungen unter Beachtung strenger Umweltvorschriften kennzeichnen diese Produkte. Viele innovative Produkte von Caimi Brevetti wurden wegen ihres ausgezeichneten Designs in unterschiedlichen Museen und Ausstellungen gezeigt. Unzählige Auszeichnungen, wie zum Beispiel der Preis ADI "Compasso d'Oro" und der Preis DesignEuropa Awards vom Amt der europäischen Union für geistiges Eigentum (EUIPO), heben die Produkte hervor.

E Fundada en 1949, Caimi Brevetti S.p.A. es una de las principales realidades productivas europeas orientadas al diseño en el sector de la decoración y mobiliario de oficina y del contract. Decir Caimi Brevetti es decir experimentación de nuevos materiales y nuevas tecnologías industriales, apuntando no sólo a una mejor productividad, sino también a lograr un menor impacto ambiental, obtenido a través de elaboraciones menos contaminantes y el uso de materiales reciclados y reciclables. Bajo esta óptica, los sistemas patentados des paneles acústicos y las tecnologías patentadas Snowsound sintetizan diseño, elevadas prestaciones técnicas y funcionalidad, todo esto concebido en el más riguroso respeto por el medioambiente. Las múltiples iniciativas de Caimi Brevetti en el sector del diseño y de la cultura han llevado a la exposición de sus productos en muestras y museos y ha sido protagonista de dos importantes reconocimientos, entre los cuales el Premio Compasso d'Oro ADI y el Premio DesignEuropa Awards de EUIPO (European Union Intellectual Property Office).

I I prodotti Snowsound sono progettati, sviluppati e fabbricati in Italia.

EN Snowsound products are designed, developed and manufactured in Italy.

F Les produits Snowsound sont conçus, développés et fabriqués en Italie.

D Die Snowsound-Produkte werden in Italien entworfen, entwickelt und produziert.

E Los productos Snowsound se han diseñado, desarrollado y fabricado en Italia.





Research & patents

I Le tecnologie ed i prodotti Snowsound annoverano diversi brevetti, frutto di una intensa fase di ricerca e sviluppo tuttora in corso, anche grazie alle collaborazioni continuative con Università ed Istituti di ricerca.

EN Snowsound technologies and products are covered by a variety of patents, the result of intensive research and development that is still in progress, partly due to our ongoing partnerships with universities and research institutions.

D Die Technologien und die Produkte von Snowsound sind von verschiedene Patenten erfasst, die das Ergebnis eines eingehenden Forschungs- und Entwicklungsprozesses sind, der – dank der fortlaufenden Zusammenarbeit mit Universitäten und Forschungsinstituten – auch weiterhin fortgeführt wird.

F Les technologies et les produits Snowsound comptent plusieurs brevets, qui sont le fruit d'une intense activité de recherche et de développement toujours en cours, grâce également à la collaboration continue avec des universités et des instituts de recherche.

E Las tecnologías y los productos Snowsound cuentan con varias patentes, logros de la intensa fase de investigación y desarrollo que aún no se ha acabado y gracias también a la continua colaboración con las Universidades y Centros de Investigación.



Snowsound awards

I Le innovazioni tecnologiche di Snowsound ed il design dei prodotti realizzati con queste particolari tecnologie hanno ottenuto importanti riconoscimenti a livello internazionale. Tra gli altri riconoscimenti, Snowsound ha ricevuto negli Stati Uniti il premio "International CES Innovations Design and Engineering Awards" considerato il più importante riconoscimento al mondo per l'innovazione nel campo dell'elettronica e dell'Audio/Video, il premio Compasso d'Oro e il premio DesignEuropa Awards, assegnato dall'Ufficio dell'Unione Europea per la proprietà intellettuale (EUIPO).

F Les innovations technologiques de Snowsound et le design des produits réalisés avec ces technologies particulières, ont obtenu d'importants reconpenses au niveau international. Parmi les autres, Snowsound a remporté aux Etats-Unis le prix "International CES Innovations Design and Engineering Awards" considéré comme le plus important prix au monde pour l'innovation dans le domaine de l'électronique et de l'audio/vidéo, le prix Compasso d'Oro ADI et le prix DesignEuropa Awards, attribué par l'Office de l'Union Européenne pour la Propriété Intellectuelle (EUIPO).

D Die technologischen Innovationen von Snowsound sowie das Design der mit Hilfe dieser besonderen Technologien erstellten Produkte wurden mit international wichtigen Auszeichnungen prämiert. Unter anderem erhielt Snowsound den Preis "International CES Innovations Design and Engeneering Awards" in U. S. A., weltweit als die wichtigste Auszeichnung im Bereich Elektronik und Audio/Video angesehen, sowie den Preis "Compasso d'oro" und den Preis "DesignEuropa Awards", der vom Amt der Europäischen Union für Geistiges Eigentum (EUIPO) verliehen wird.

E Las innovaciones tecnológicas de Snowsound y el diseño de los productos realizados con estas tecnologías específicas fueron premiados en el ámbito internacional. Entre otros reconocimientos en Estados Unidos, a Snowsound se le otorgó el premio "International CES Innovations Design and Engineering Awards" que se considera la distinción para la innovación más importante en el mundo para el sector de la electrónica y del Audio/Video. El premio Compasso d'Oro y el premio DesignEuropa Awards de EUIPO (European Union Intellectual Property Office).

EN The technological innovations of Snowsound and the design of products made with these special technologies have achieved major world recognitions. Among other honors, in the United States Snowsound was awarded the "International CES Innovations Design and Engineering Awards" considered the most prestigious award for innovation in the field of electronics and audio/video, the Compasso d'Oro award and the DesignEuropa Awards by EUIPO (European Union Intellectual Property Office).



XXIV Compasso d'Oro
(Italy)



DesignEuropa Awards
by EUIPO (European Union
Intellectual Property Office)



International CES
Innovations Design
and Engineering Awards
(U.S.A.)



Trophée de l'Innovation
Bureaux Expo
(France)



German Design Award
Product: Baffle
(Germany)



German Design Award
Product: President
(Germany)



HiP Interior Design
Product: Blade
(U.S.A.)



German Design Award
(Germany)



Product Design Awards
(Dubai, U.A.E.)



Gran Design Etico
International Award
(Italy)



Design Journal
Best of 2015
(U.S.A.)



Best of NeoCon
(U.S.A.)



German Design Award
(Germany)



German Design Award
Product: Analysis software
(Germany)



Ho.Re.Ca.
Innovazione dell'anno
(Italy)



Gran Design Etico
International Award
(Italy)



German Design Award
(Germany)



HiP Interior Design
Product: Sipario
(U.S.A.)



Product Innovation
Merit Award
(U.S.A.)



Best of NeoCon
Product: Diesis
(U.S.A.)



Best of NeoCon
(U.S.A.)



Best of NeoCon
(U.S.A.)



ADI Design Index
(Italy)



Trophée de l'Innovation
Workspace Expo
(France)



Best of NeoCon
Product: Analysis software
(U.S.A.)



Gran Design Etico
International Award
(Italy)



German Design Award
Product: Diesis
(Germany)

Design & designers

I Le performance acustiche dei prodotti Snowsound prendono forma nei progetti di grandi designers. Una moltitudine di forme e colori pensati sia per essere parte visibile e caratterizzante del progetto, sia per integrarsi con discrezione negli ambienti. Risolvere le problematiche acustiche, dalle più semplici alle più complesse, con una gamma integrata di prodotti basati su un approccio del tutto innovativo.

F Les performances acoustiques de Snowsound prennent forme dans les projets de grands designers. Une multiplicité de formes et de coloris conçus aussi bien pour être la partie visible et distinctive du projet, que pour s'intégrer discrètement dans les différents espaces. Résoudre les problématiques d'acoustique, des plus simples aux plus complexes, avec une gamme intégrée de produits basés sur une approche tout à fait innovante.

EN Snowsound acoustic performance takes shape in projects thanks to great designers. Many shapes and colours are designed to be a visible and distinctive part of the project and to discreetly integrate into the spaces. Resolving acoustic problems, from the simplest to the most complex, with a complete range of products based on a totally innovative approach.

D Die akustische Wirkung von Snowsound nimmt in Projekten großer Designer Gestalt an. Eine Vielfalt an Formen und Farben ermöglichen die Gestaltung eines sichtbaren und charakteristischen Teil des Projekts ebenso wie eine diskrete Integration in den Räumen. Die Lösung von akustischen Problemen, von einfachen bis hin zu sehr komplexen, mit einer vollständigen Produktlinie, stellt einen vollkommen innovativen Ansatz dar.

E Las prestaciones acústicas de Snowsound se plasman en los proyectos de diseñadores afamados. Un sinfín de formas y colores concebidos tanto para ser parte visible que caracteriza el proyecto, como también elemento que se integra con discreción en su entorno. Solucionar los problemas acústicos, de los más sencillos a los más complejos, con una gama integrada de productos basados en un enfoque muy innovador.

Gillo Dorfles



Lorenzo Damiani



Michele De Lucchi

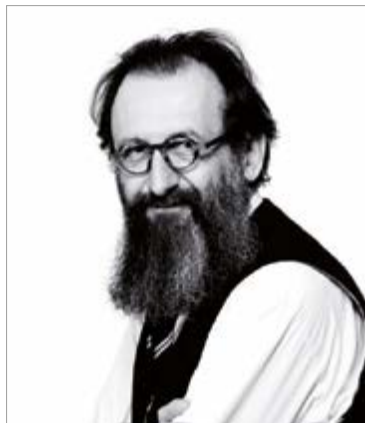

Sezgin Aksu



Marc Sadler



**Alessandro Mendini
Francesco Mendini**



Lorenzo Palmeri



Moreno Ferrari



**Alberto Meda
Francesco Meda**



Caimi Lab



XXI
Triennale
International
Exhibition
 Milan 2016
 02.04–12.09
21st Century.
Design
After Design

XXI Triennale Internazionale di Milano,
 "Snowsound by Caimi:
 il design come non lo avete mai sentito"

XXI International Exposition at Milan's
 Triennale Museum,
 "Snowsound by Caimi:
 Design as you've never heard it"

In occasione della XXI Esposizione Internazionale della Triennale di Milano, 21st Century. Design After Design, Caimi Brevetti ha presentato la mostra "Snowsound by Caimi. Il design come non l'avete mai sentito" con protagonisti il suono e il design come soluzione estetica ed espressiva alle esigenze della vita.

EN For the XXI International Exposition at Milan's Triennale Museum with the theme of "21st Century. Design After Design," Caimi Brevetti presented "Snowsound by Caimi. Design as you've never heard it". This exhibition featured sound and design as an aesthetic solution for the needs of life.

F Lors de la XXI^{ème} Exposition Internationale de la Triennale de Milan, 21. ème siècle. Design After Design, Caimi Brevetti a présenté "Snowsound by Caimi. Le design comme vous ne l'avez jamais entendu" qui voit protagonistes le son et le design comme solution esthétique et expressive pour les exigences de la vie.

D Anlässlich der XXI. Internationalen Ausstellung der Triennale in Mailand (21st Century. Design After Design) ist Caimi Brevetti mit der Ausstellung "Snowsound by Caimi. Design wie Sie es noch nie gehört haben" als Italien repräsentierendes Unternehmen ausgewählt worden. Bei dieser Ausstellung standen Klang und Design als ästhetische Lösung für die Ansprüche des täglichen Lebens im Mittelpunkt.

E Con ocasión de la XXI Exposición Internacional de la Triennale de Milán, 21st Century. Design After Design, Caimi Brevetti presentó la muestra "Snowsound by Caimi. El diseño como no lo oísteis nunca" cuyos protagonistas, el sonido y el diseño ofrecen una solución estética y expresiva a las exigencias de la vida.

MUSEO NAZIONALE SCIENZA E TECNOLOGIA LEONARDO DA VINCI

I I pannelli fonoassorbenti FLAP sono stati scelti dal Museo della Scienza e della Tecnologia Leonardo Da Vinci di Milano, in collaborazione con il CERN (Organizzazione Europea per la Ricerca Nucleare) e con l'INFN (Istituto Nazionale di Fisica Nucleare), all'interno della Mostra permanente "Extreme, alla ricerca delle particelle", per la realizzazione della sala "Do Not Disturb". La sala è stata creata con l'intento di simulare il "Silenzio Cosmico", privo di disturbi, condizione necessaria per la ricerca, giocando con la metafora del rumore.

EN The Leonardo Da Vinci Science and Technology Museum in Milan has chosen FLAP sound-absorbing panels for its "Extreme, In Search of Particles" permanent exhibition. This show is in collaboration with CERN - European Organization for Nuclear Research, and INFN - the National Institute of Nuclear Physics. The panels are used inside the "Do Not Disturb" room to simulate "cosmic silence", therefore a situation of total absence of background noise that is necessary for research thus playing with the metaphor of noise.

F Les panneaux phono-absorbants FLAP ont été choisis par le Musée de la Science et de la Technologie Leonardo da Vinci de Milan, en collaboration avec le CERN (Organisation européenne pour la recherche nucléaire) et l'INFN (Institut national de physique nucléaire), à l'intérieur de l'Exposition permanente "Extreme, à la recherche des particules", pour la réalisation de la salle "Do Not Disturb". La salle a été créée dans le but de simuler le "silence cosmique" sans perturbation, une condition nécessaire pour la recherche, en jouant sur la métaphore du bruit.

D Die schallabsorbierenden FLAP-Paneele wurden vom Mailänder Museum für Wissenschaft und Technologie Leonardo Da Vinci zusammen mit dem CERN (Europäische Organisation für Kernforschung) und dem INFN (Nationales Institut für Kernphysik) für die Dauerausstellung "Extreme, auf der Suche nach den Partikeln" für die Einrichtung des Raums "Do Not Disturb" ausgewählt. Der Raum wurde mit der Absicht gestaltet, die Stille im Weltraum ganz ohne Störungen zu simulieren und um mit der Metapher des Lärms zu experimentieren.

E El Museo de la Ciencia y de la Tecnología Leonardo Da Vinci de Milán, con la colaboración de CERN (Organización Europea para la Investigación Nuclear) y de INFN (Instituto Nacional de Física Nuclear), han escogido los paneles fonoabsorbentes FLAP, en el ámbito de la Muestra permanente "Extreme, en busca de las partículas", para realizar la sala "Do Not Disturb". La sala se ha montado con el fin de simular el "Silencio Cósmico", sin interferencias, condición necesaria para la investigación, jugando con la metáfora del ruido.

Museo Nazionale Scienza e Tecnologia Leonardo Da Vinci,
"Extreme: alla ricerca delle particelle"

The Leonardo Da Vinci Science and Technology Museum,
"Extreme, In Search of Particles"



The sound

I I suoni sono formati da onde che tendono ad essere riflesse dalle superfici rigide con limitato potere assorbente, quali per esempio il cemento, il marmo o il vetro. In ambienti realizzati con queste tipologie di materiali si possono generare echi e riverberi, spesso molto fastidiosi, che non consentono di ascoltare e dialogare in maniera confortevole. I materiali fonoassorbenti nascono dall'esigenza di migliorare l'acustica in questi ambienti. Le caratteristiche dei prodotti fonoassorbenti tradizionali tendono a manifestare la capacità di assorbire meno le basse frequenze (sotto i 500 Hz), progressivamente di più le medie frequenze (tra i 500 e i 2000 Hz) ed in misura maggiore le alte (sopra i 2000 Hz).

EN Sound is formed by waves that tend to be reflected from solid surfaces having limited absorption capacity such as, for example, concrete, marble or glass. In rooms made with these types of materials, often very annoying echoes and reverberations can be created, making it difficult to listen and converse in comfort. Sound absorbing materials are created from the need to improve acoustics in these environments. The sound absorbing characteristics of traditional products tend to demonstrate less capacity to absorb low frequencies (below 500 Hz), progressively more with regard to the midrange (between 500 and 2,000 Hz) and to a greater extent with regard to the high frequencies (above 2,000 Hz).

D Töne sind Wellen, welche sich auf harten Oberflächen mit keinem oder wenig Absorptionsvermögen (wie zum Beispiel Beton, Marmor oder Glas) reflektieren. In Räumen in welchen viele harte Oberflächen wie große Glasflächen, Steinböden oder Betonwände vorhanden sind entsteht oft eine unangenehme Raumakustik mit Echos welche die Unterhaltung oder das Zuhören bei Vorträgen erschweren. Schallabsorbierende Materialien wurden aus dem Bedürfnis entwickelt die Raumakustik in solchen Umgebungen zu verbessern. Schallabsorbierende Produkte aus traditionellen Materialien verfügen oft über zu geringe Fähigkeit niedrige Frequenzbereiche (unter 500 Hz) aufzunehmen. Sie beginnen erst im mittleren Frequenzbereich (zwischen 500 und 2000 Hz) effektiv zu absorbieren und erreichen die volle Dämpfung erst bei hohen Frequenzen (über 2000 Hz).

F Les sons sont formés par des vagues qui tendent à être réfléchies par les surfaces rigides à pouvoir absorbant limité tels que par exemple le ciment, le marbre et le verre. Dans des espaces réalisés avec ce type de matériaux ils peuvent produire des échos et des réverbérations, souvent très nuisibles, qui ne permettent pas de dialoguer ou d'écouter d'une manière confortable. Les matériaux phono-absorbants naissent de l'exigence d'améliorer l'acoustique des espaces. Les caractéristiques des produits phono-absorbants traditionnels tendent à manifester leur capacités d'absorber moins les basses fréquences (au-dessous de 500 Hz) et progressivement plus les fréquences moyennes (entre 500 et 2000 Hz) et encore plus les fréquences plus hautes (plus de 2000 Hz).

E Los sonidos están formados por ondas que tienden a reflejarse sobre las superficies rígidas con limitado poder absorbente, como por ejemplo el cemento, el mármol o el vidrio. En ambientes realizados con este tipo de materiales se pueden generar ecos y rebotes, a menudo muy fastidiosos, que no permiten escuchar y dialogar con comodidad. Los materiales fonoabsorbentes nacen de la exigencia de mejorar la acústica en estos ambientes. Las características de los productos fonoabsorbentes tradicionales tienden a manifestar la capacidad de absorber menos las bajas frecuencias (por debajo de 500 Hz), progresivamente más las medias frecuencias (de 500 a 2000 Hz) y más las altas (por encima de los 2000 Hz).

Acoustic comfort

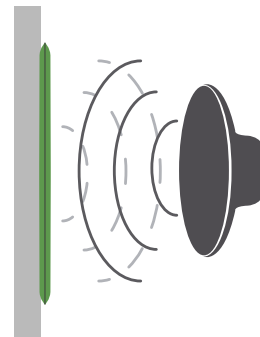
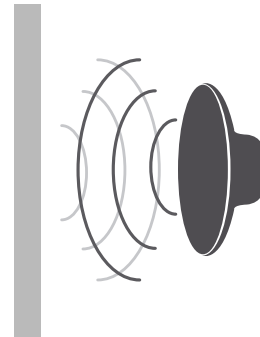

I Le tecnologie Snowsound consentono di ottenere una correzione acustica in modo semplice e rapido, sia in nuovi ambienti che in quelli esistenti. L'esigenza di vivere e lavorare in ambienti meno rumorosi, riducendo il fastidioso riverbero acustico, trova finalmente una risposta in prodotti innovativi adatti a risolvere svariate esigenze.

EN Snowsound technologies attain acoustic correction easily and quickly, in new areas as well as in existing spaces. The need to live and work in quiet spaces, reducing annoying acoustic reverberation, is finally met with these innovative products, ideal for resolving a variety of needs.

F Les technologies Snowsound permettent d'obtenir une correction acoustique simplement et rapidement, dans des environnements nouveaux autant que dans des environnements préexistants. Des produits innovants en mesure de satisfaire de multiples exigences, qui répondent enfin au besoin de vivre et de travailler dans des environnements moins bruyants en réduisant la pénible réverbération acoustique.

D Die Snowsound -Technologien ermöglichen eine schnelle und einfache Klangverbesserung in neuen oder schon bestehenden Räumen. Dem Bedürfnis nach einem ruhigeren Lebens- und Arbeitsumfeld wird endlich nachgekommen, indem der nervtötende Nachhall begrenzt wird. Ermöglicht wird dies durch innovative Produkte, die unterschiedlichen Ansprüchen genügen.

E Con las tecnologías Snowsound se pueden hacer correcciones acústicas de forma sencilla y rápida, tanto en ambientes nuevos como en los ya existentes. La necesidad de vivir y trabajar en locales con menos ruido, limitando la molesta reverberación acústica, por fin se puede atender con productos novedosos aptos a solucionar las diferentes exigencias.

Software & projects

I L'azienda ha sviluppato innovativi software di calcolo che permettono di stimare in breve tempo la quantità di materiale necessario per rendere gli ambienti acusticamente confortevoli (Snowsound + Snowsound Fiber Products + Snowsound Fiber Textiles).

EN The company has developed an innovative calculation software that allows to quickly estimate the necessary amount of material in order to achieve acoustic comfort (Snowsound + Snowsound Fiber Products + Snowsound Fiber Textiles).

F La société a développé des logiciels innovants pour calculer rapidement la quantité de matériel nécessaire pour obtenir des espaces acoustiquement confortables (Snowsound + Snowsound Fiber Products + Snowsound Fiber Textiles).

D Das Unternehmen hat innovative Berechnungs-Softwares entwickelt, die eine schnelle Einschätzung der zur akustisch angenehmen Gestaltung von Räumen notwendigen Material-quantität erlauben (Snowsound + Snowsound Fiber Products + Snowsound Fiber Textiles).

E La compañía ha desarrollado un innovador software que permite una estimación rápida de la cantidad necesaria de materiales para alcanzar el confort acústico (Snowsound + Snowsound Fiber Products + Snowsound Fiber Textiles).

Snowsound Analysis software



Best of NeoCon
(U.S.A.)



German Design
Award (Germany)

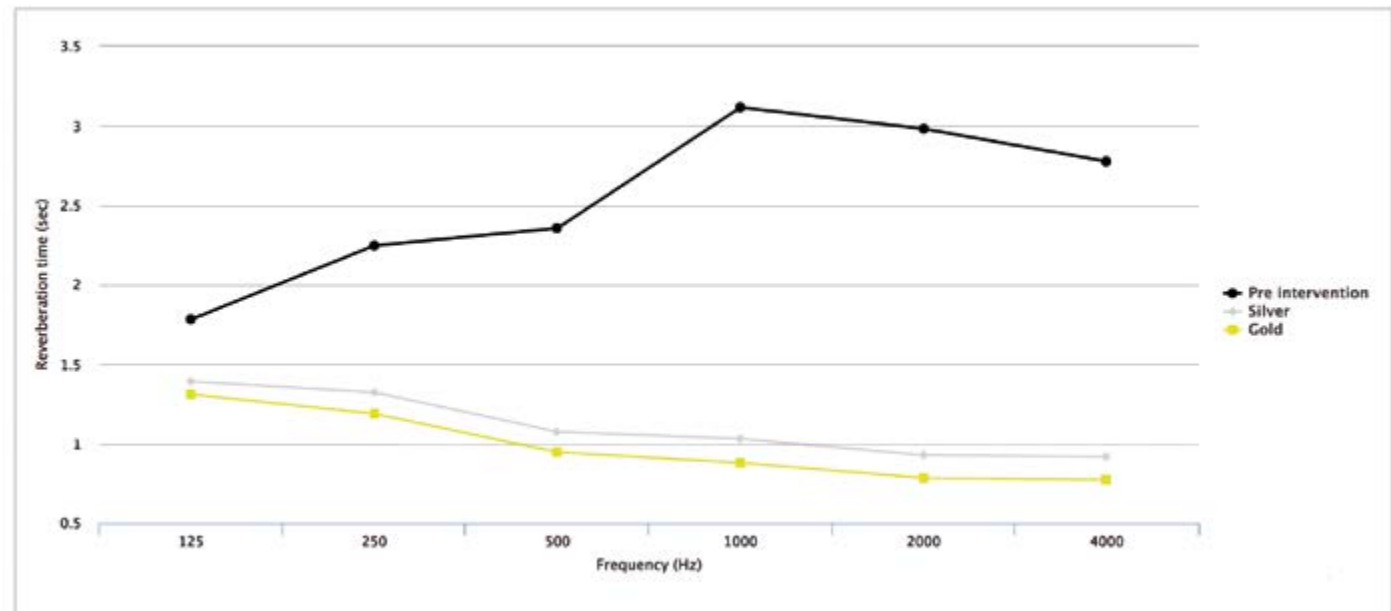

Experience the difference



Without/With
Snowsound
Technology



Without/With
Snowsound
Fiber Textiles



Greenguard Gold



I GREENGUARD GOLD CERTIFICATION

I prodotti Snowsound, Snowsound Fiber e Snowall hanno ricevuto la certificazione Greenguard Gold, che convalida le loro caratteristiche di bassa emissione ed il loro contributo alla qualità dell'ambiente. Campioni significativi dei prodotti che portano il marchio della certificazione Greenguard sono stati testati, in maniera indipendente, ed è stato certificato che essi rispettano i rigorosi standard di certificazione UL per Greenguard, che sono tra i più stringenti al mondo. Per contribuire alla riduzione dell'inquinamento dell'aria gli architetti, i designers, i prescrittori ed i proprietari degli immobili dovrebbero scegliere materiali e prodotti che rilasciano la minor quantità possibile di agenti inquinanti (ovvero prodotti a bassa emissione). Il miglior modo di raggiungere questo obiettivo è scegliere prodotti che hanno ottenuto la certificazione Greenguard, ovvero che sono stati testati per oltre 10.000 sostanze chimiche e non emettono significativi livelli di agenti chimici inquinanti. I prodotti certificati Greenguard Gold offrono i più stringenti criteri di certificazione per i soggetti più "sensibili", come bambini ed anziani, e sono ideali per l'utilizzo in ambienti quali edifici scolastici e strutture di cura. I prodotti con certificazione Greenguard contribuiscono anche all'acquisizione di crediti nel quadro della sezione indoor environmental quality (qualità ambientale degli interni) del sistema di valutazione degli edifici LEED (leadership in energy and environmental design - leadership nel design energetico ed ambientale).

EN GREENGUARD GOLD CERTIFICATION

Snowsound, Snowsound Fiber and Snowall products have received Greenguard Gold certification, indicating that they are low emitting products and do contribute to improve indoor air quality. Representative samples of products bearing the Greenguard certification mark have been independently tested and certified that they meet UL's rigorous third-party Greenguard certification standards, which are among the most stringent in the world.

To help reduce indoor air pollution, architects, designers, specifiers and building owners should choose materials and products that release the fewest possible pollutants (also known as low-emitting products). A great way to do this is by choosing products that are Greenguard certified, which means they have been screened for over 10,000 chemicals and do not emit high levels of chemical pollutants. Greenguard Gold certified products offer stricter certification criteria for sensitive individuals, such as children and the elderly, and are ideal for use in schools and healthcare facilities.

Greenguard certified products also contribute toward credits within the indoor environmental quality section of the leadership in energy and environmental design (LEED) building rating system.

F CERTIFICATION GREENGUARD GOLD

Les produits Snowsound, Snowsound Fiber et Snowall ont reçu la certification Greenguard Gold qui confirme leurs caractéristiques de faible émission et donc leur apport à la qualité de l'environnement. Des échantillons significatifs des produits portant la marque de la certification Greenguard ont été testés - sur base indépendante et on a certifié qu'ils respectent les standards de certification UL pour Greenguard, qui figurent parmi les plus rigoureux au monde. Pour contribuer à la réduction de la pollution de l'environnement, les architectes, les designers, les prescripteurs et les propriétaires des immeubles devraient choisir des matériaux et des produits dégageant la quantité la plus minime possible d'agents polluants (à savoir des produits à faible émission). La meilleure solution est donc choisir des produits munis de la certification Greenguard, testés pour plus de 10.000 substances chimiques sans émettre des niveaux significatifs d'agents chimiques polluants. Les produits certifiés Greenguard Gold offrent les critères de certification les plus sévères pour les "sujets" les plus sensibles tels que les enfants et les personnes âgées, l'idéal dans des milieux comme les écoles et les structures hospitalières. Les produits certifiés Greenguard contribuent également à l'acquisition de crédits dans le cadre de la section indoor environmental quality (qualité environnementale des intérieurs) du système d'évaluation des édifices LEED (leadership in energy and environmental design - leadership dans le design en matière d'énergie et d'environnement).

No formaldehyde

D GREENGUARD GOLD-ZERTIFIZIERUNG

Die Produkte Snowsound, Snowsound Fiber und Snowall sind mit der Greenguard Gold-Zertifizierung ausgezeichnet worden, die die Anwendung von Materialien mit geringen chemischen Emissionen und deren Beitrag zur verbesserten Raumqualität bezeugt. Eine bedeutende Stückzahl von Produkten, die das Greenguard-Zeichen tragen, sind unabhängig voneinander getestet worden. Alle Produkte haben gezeigt den Greenguard Zertifizierungskriterien von UL, die zu den strengsten Kriterien der Welt gehören, zu entsprechen. Architekten, Designer, Planer und Immobilienbesitzer sollten nach Möglichkeit gering verschmutzende Materialien und Produkte (oder Produkte mit geringen chemischen Emissionen) wählen und dadurch zu einer wesentlich besseren Qualität der Raumluft beitragen. Der beste Weg dieses Ziel zu erreichen ist es jene Produkte einzusetzen, die mit dem Greenguard-Zeichen versehen sind, d.h. die auf über 10.000 chemische Substanzen geprüft worden sind und keine bedeutende chemische Emissionen freisetzen. Die Greenguard Goldzertifizierten Produkte unterliegen äußerst strengen Zertifizierungskriterien, welche die Sicherheit sensiblerer Menschen wie Kinder oder ältere Personen stärker berücksichtigen und daher zur Anwendung in Schulen oder Gesundheitseinrichtungen geeignet sind. Greenguardzertifizierte Produkte tragen auch dazu bei mehr Ansehen im Bereich Indoor environmental quality des Gebäudebewertungssystems LEED (Leadership in energy and environmental design) zu erlangen.

E GREENGUARD GOLD CERTIFICATION

A los productos Snowsound, Snowsound Fiber y Snowall se les ha otorgado el certificado Greenguard Gold, que garantiza sus características de baja emisión y su contribución a la calidad del ambiente. Se han probado, de forma independiente, algunas muestras significativas de los productos que llevan la marca de la certificación Greenguard y se certificó que cumplen los rigurosos estándares de certificación UL para Greenguard, que son entre los más estrictos del mundo. Los arquitectos, los diseñadores, los prescriptores y los propietarios de inmuebles deberían contribuir a la reducción de la contaminación del aire escogiendo materiales y productos que emiten la menor cantidad posible de agentes contaminantes (es decir, productos de baja emisión). La forma más apropiada para lograr este objetivo es la de escoger productos a los que se les haya otorgado el certificado Greenguard, es decir en los que se realizaron ensayos para más de 10.000 sustancias químicas y no emitieron niveles significativos de agentes químicos contaminantes. Los productos certificados Greenguard Gold gracias a sus criterios de certificación tan estrictos son excelentes para las personas más "sensibles", como los niños y los mayores, y para los ambientes de edificios escolares y centros de salud. A los productos certificados Greenguard también se les otorga créditos en la sección indoor environmental quality (calidad ambiental en interiores) del sistema de evaluación de edificios LEED (leadership in energy and environmental design - líder en eficiencia energética y diseño sostenible).

I Snowsound e Snowsound Fiber hanno contenuto di formaldeide non rilevabile, test eseguito secondo la norma UNI EN 717-2.

EN Snowsound and Snowsound Fiber have no detectable formaldehyde contents, tested according to the UNI EN 717-2.

F La teneur en formaldéhyde des Snowsound et Snowsound Fiber est non détectable; test effectué conformément à la norme UNI EN 717-2.

D Formaldehyd ist in den Snowsound und Snowsound Fiber nicht messbar, der Test wurde gemäß der Norm UNI EN 717-2.

E Snowsound y Snowsound Fiber tienen un contenido no detectable de formaldehído, prueba llevada a cabo conformemente a la norma UNI EN 717-2.

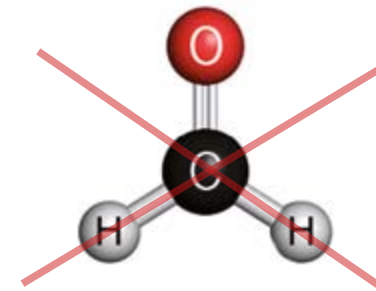

CE

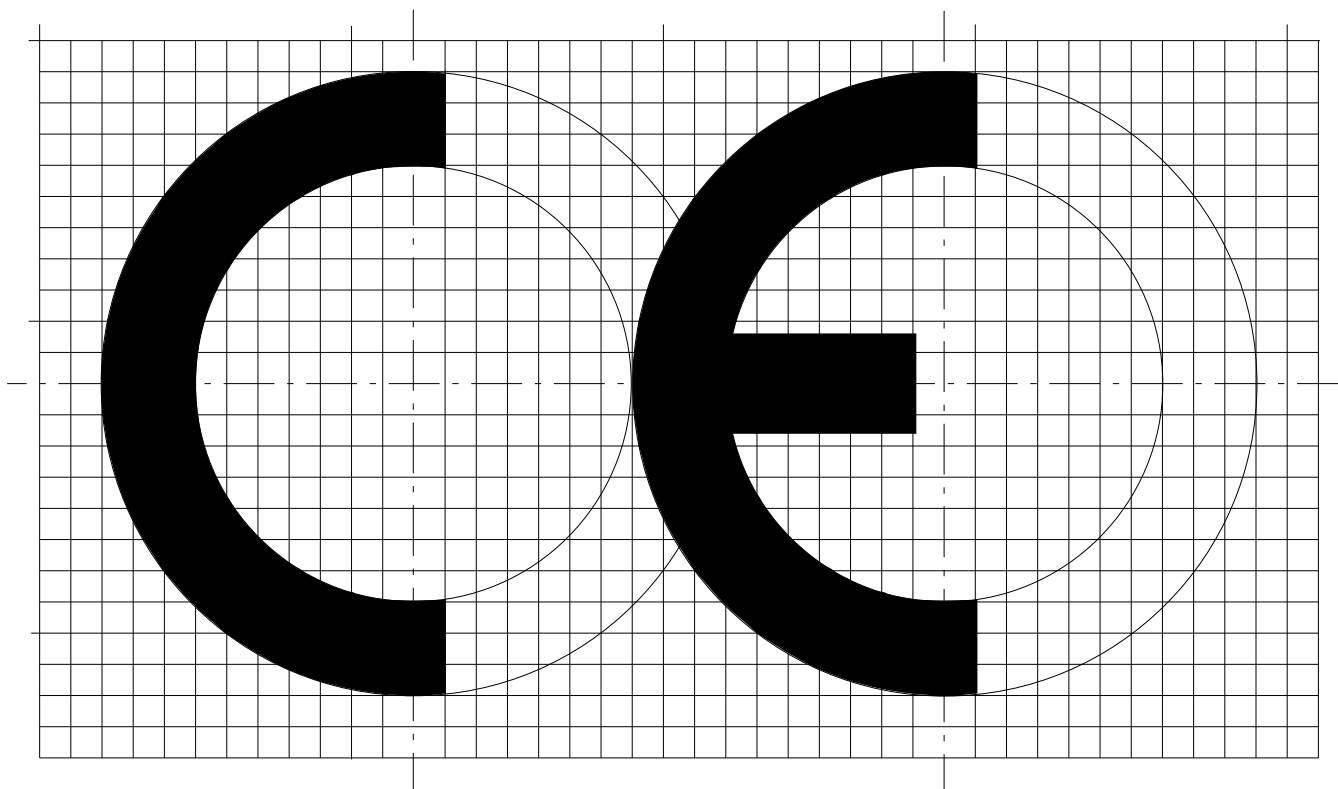

I I pannelli Snowsound sospesi a soffitto, sono muniti di marcatura CE ai sensi della norma di prodotto armonizzata EN 13964 per la destinazione di uso come controsoffitto. Le schede tecniche e la dichiarazione di prestazione che vengono fornite per queste tipologie di prodotti permettono al cliente di valutare e scegliere la soluzione tecnica migliore sulla base delle sue esigenze e dei requisiti dell'installazione.

EN Snowsound panels, when hanging from the ceiling, all bear the CE mark, according to the harmonised technical specification EN 13964 for use as a suspended ceiling. The technical data sheets and the performance declaration provided for these types of products allow customer to assess and choose the best technical solution depending on the installation needs and requirements.

F Les panneaux Snowsound suspendus au plafond, sont munis du marquage CE conformément à la norme de produit harmonisée EN 13964 pour l'emploi comme plafond suspendu. Les fiches techniques et la déclaration de prestation qui sont fournies pour ces typologies de produits permettent au client d'évaluer et de choisir la meilleure solution technique en fonction de ses exigences et des caractéristiques de l'installation.

D Die Snowsound -Paneele für die Deckenmontage weisen die CE-Kennzeichnung entsprechend den harmonisierten Produktnormen EN 13964 für einen Einsatz als abgehängte Decke auf. Die Datenblätter und Leistungserklärungen, die für diese Produkte geliefert werden, erlauben es dem Kunden die beste technische Lösung abhängig von den Montageanforderungen und weiteren Bedürfnissen zu wählen.

E Los paneles Snowsound suspendidos al techo, llevan la marca CE conforme a la norma de armonización EN 13964 sobre los productos que se usan en techos suspendidos. Las fichas técnicas y la declaración de prestaciones que se entregan para este tipo de productos ofrecen al cliente la posibilidad de evaluar y escoger la solución técnica más adecuada conforme a sus necesidades y especificaciones para la instalación.

Fire

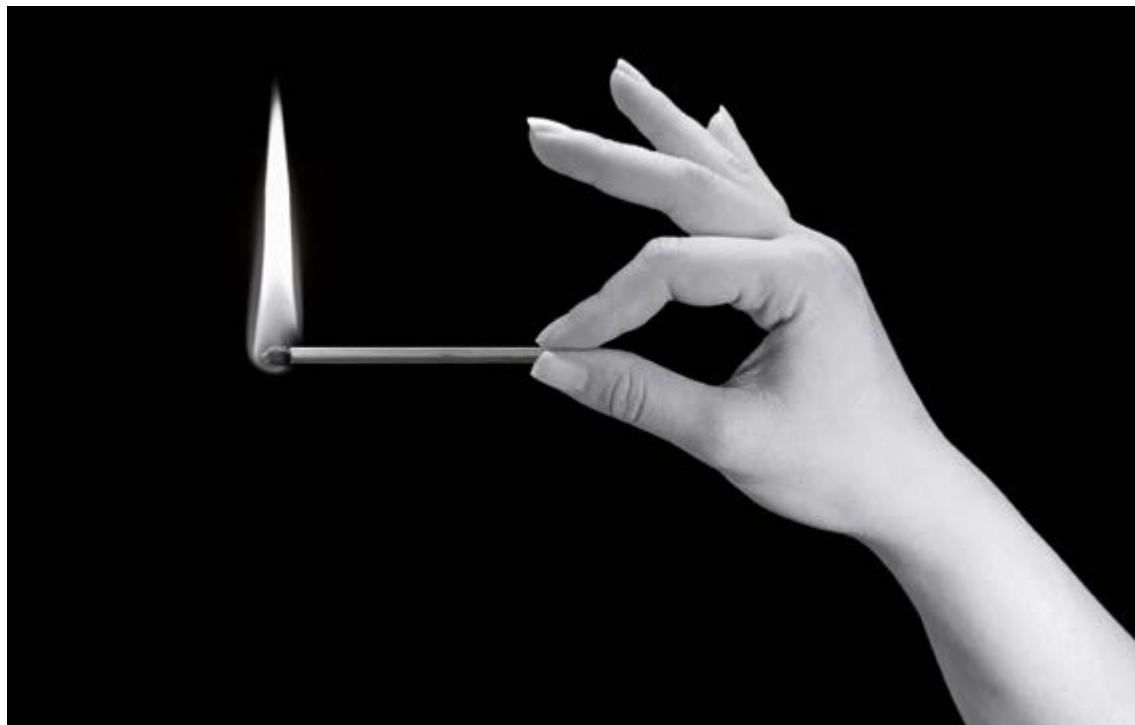

I Il pannello monomaterico Snowsound nel suo insieme tessuto esterno e materiale fonoassorbente interno, ha Classe 1 Italia di reazione al fuoco ed Euroclass B-s2, d0. I test sono stati effettuati su pannelli finiti, cioè composti da materiale fonoassorbente rivestito in tessuto sui due lati, come correttamente richiesto dalla normativa, che per questa tipologia di prodotti non prevede la possibilità di testare separatamente imbottitura e tessuto di copertura. Snowsound Fiber ha Classe 1 Italia di reazione al fuoco ed Euroclass B-s2, d0 o B-s1, d0 in base al tipo di materiale.

EN The single material panel Snowsound, in its entirety, external fabric and soundabsorbing interior material, has Italian Class 1 and Euroclass B-s2, d0 classification as to reaction to fire. The tests were done on finished panels, composed of sound-absorbing materials upholstered in fabric on both sides, as required by law. This type of product is not conducive to testing the upholstery and padding separately. Snowsound Fiber has Italian Class 1 reaction to fire and Euroclass B-s2, d0 or B-s1, d0 depending on the type of material.

F Le panneau Snowsound, en un seul matériel, dans sa composition de tissu à l'extérieur et de matériel phono-absorbant à l'intérieur, est classifié Classe 1 Italie pour la réaction au feu et Euroclass B-s2, d0. Les tests ont été effectués sur panneaux finis, à savoir composés de matériau phono-absorbant revêtu de tissu des deux côtés, conformément à la loi qui n'envisage pas, pour ce type de produit, la possibilité de tester le rembourrage et le tissu de revêtement séparément. Snowsound Fiber atteint la Classe 1 en Italie pour la réaction au feu et l'Euroclasse B-s2, d0 ou B-s1, d0, selon le type de matériau.

D Das Paneel Snowsound, besteht aus nur einem Material und die textile Oberfläche sowie das schallabsorbierende Innenmaterial entsprechen der Italienischen Klasse 1 für feuerfeste Materialien und der Euroklasse B-s2, d0. Die Tests wurden an fertigen Paneelen durchgeführt. Diese bestanden aus schalldämpfendem Material mit Stoffbezug auf beiden Seiten, wie es von der Vorschrift gefordert wird. Für diese Art von Produkt ist es nicht erlaubt, Polsterung und Bezugsstoff separat voneinander zu testen. Snowsound Fiber wurde in Italien in Hinsicht auf das Brandverhalten in Klasse 1 und je nach Material in die Euroclass B-s2, d0, bzw. B-s1, d0 eingestuft.

E El panel Snowsound, de material único, en su conjunto tejido externo y material fonoabsorbente interno, posee Clase 1 Italia de reacción al fuego y Euroclass B-s2, d0. Las pruebas se han llevado a cabo con paneles acabados, es decir, con el material de relleno acústico absorbente y ambas caras forradas con el tejido, como correctamente especificado en la normativa, que para este tipo de productos no contempla la posibilidad de llevar a cabo pruebas independientes para el acolchado y la tela del forro. Snowsound Fiber tiene la Clase 1 Italia de reacción al fuego y Euroclass B-s2, d0 o B-s1, d0 respectivamente conforme al tipo de material.

Snowsound Technology

pag. 10

pag. 06

pag. 28

pag. 29

pag. 26

pag. 30

pag. 31

Design
& Designers

Research
& patents

“A” Class

Decibels'
reduction

Sound
quality

100% sound
absorbing

Strong, light
& thin

- Michele De Lucchi
- Marc Sadler
- Alberto e Francesco Meda
- Lorenzo Palmeri
- Lorenzo Damiani
- Sezgin Aksu
- Gillo Dorfles
- Caimi Lab

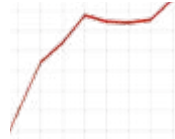

pag. 18 . pag. 32 . pag. 19 . pag. 31 . pag. 20 . pag. 21 . pag. 33

Greenguard
Gold

Eco-friendly

No formaldehyde

Hygiene
& maintenance

CE

Fire

Extreme
conditions



Snowsound Technology

I La brillante intuizione alla base della tecnologia brevettata Snowsound è l'utilizzo di pannelli composti da materiale a densità variabile, che permette di ottenere un assorbimento selettivo alle diverse frequenze e quindi di ottimizzare l'acustica dell'ambiente nonostante lo spessore molto contenuto dei pannelli. L'assenza di cornici e cuciture e la peculiarità del materiale con cui sono realizzati i pannelli, li rendono estremamente leggeri, poco ingombranti e adattabili ad ogni ambiente.

EN The brilliant intuition at the heart of Snowsound patented technology is based on the use of panels composed of material with variable density, which achieve selective absorption at different frequencies and thus optimise the acoustical environment notwithstanding the thinness of the panels. The absence of frames and seams and the unusual characteristics of the material used in the fabrication of the panels, render them extremely light, unobtrusive and adaptable to any environment.

D Die Grundlage der patentierten Snowsound Technologie besteht aus der Verwendung von Materialien unterschiedlicher Dichte. Diese Materialien absorbieren die unterschiedlichsten Frequenzbereiche und ermöglichen trotz geringer Materialstärke eine Verbesserung der Raumakustik. Die Mitesco Paneele sind, ohne Rahmen oder Nähte, aus einem Stück gefertigt, besonders leicht und passen sich an jedes Ambiente an.

F La brillante intuizione à la base de la technologie brevetée Snowsound prévoit l'emploi des panneaux en particules à densité variable, qui permet d'obtenir une absorption sélective aux différentes fréquences et par conséquent d'optimiser l'acoustique des espaces, malgré l'épaisseur très mince des panneaux. L'absence de cadres et de coutures et la spécificité du matériel de base en font des panneaux très légers, peu encombrants et qui s'adaptent très bien à tout espace.

E La brillante intuición a la base de la tecnología patentada Snowsound es el uso de paneles compuestos por materiales de densidad variable, que permite obtener una absorción selectiva en las diversas frecuencias y entonces optimizar la acústica del ambiente, no obstante el espesor muy reducido de los paneles. La ausencia de marcos y costuras y la peculiaridad del material con el que son realizados los paneles, lo vuelven muy livianos, poco voluminosos y adaptables para todos ambientes.



1 I Le superfici del pannello sono rivestite in tessuto di poliestere Trevira CS® solidamente applicato all'imbottitura interna con la quale forma un corpo unico senza soluzione di continuità. Proprietà che permette di ottenere una superficie che, pur essendo visivamente molto soft, risulta essere resistente, difficile da strappare e da perforare.

EN The surfaces of the panel are coated with Trevira CS® polyester fabric firmly bonded to the inner wadding with which it forms a single body without a break. This property makes it possible to obtain a surface which, while visually appearing very soft, actually is resistant, difficult to tear or perforate.

F Les surfaces du panneau sont recouvertes en tissu en polyester Trevira CS® bien fixé au rembourrage interne avec lequel il forme un corps unique sans solution de continuité. Il s'agit d'une caractéristique qui permet d'obtenir une surface qui, bien qu'étant du point de vue visuel très soft, est très résistante, difficile à arracher et percer.

D Die Oberfläche der Paneele werden mit Trevira CS® beschichtet. Dieser Stoff aus Polyester wird mit dem Paneel zu einem Element verbunden und bildet mit diesem eine Einheit. Die Oberfläche sieht weich und angenehm aus dennoch ist das Paneel äußerst widerstandsfähig und kann nur sehr schwer eingerissen oder durchbohrt werden.

E Las superficies del panel están tapizadas en tejido de poliéster Trevira CS® firmemente aplicada al relleno interno con el cual forma un cuerpo único, sin solución de continuidad. Propiedad que permite obtener una superficie que, aún siendo visualmente muy soft, resulta ser resistente, difícil de arrancar y perforar.

2 I Poliestere ad alta densità.
EN High density polyester.
F Polyester à haute densité.
D Polyester mit hoher Dichte.
E Poliéster de alta densidad.

3 I Poliestere a media densità.
EN Medium density polyester.
F Polyester à moyenne densité.
D Polyester mit mittlerer Dichte.
E Poliéster de mediana densidad.

4 I Poliestere a bassa densità.
EN Low density polyester.
F Polyester à basse densité.
D Polyester mit niedriger Dichte.
E Poliéster de baja densidad.

5 I Bordo rigido.
EN Rigid edge.
F Bord rigide.
D Feste Kante.
E Borde rígido.

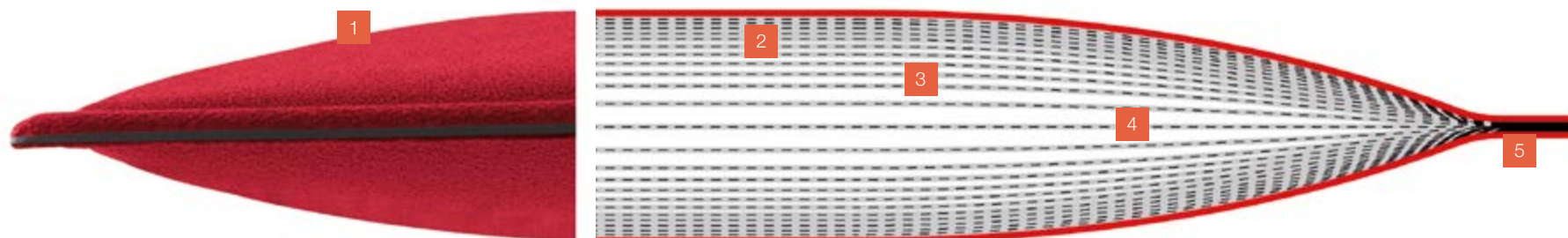

Sound quality



I Il tubo di Kundt (UNI EN ISO 10534-2) permette di rilevare valori compresi tra 0 e 1 ovvero tra 0% e 100%, non confrontabili con i valori rilevati in camera riverberante (UNI EN ISO 354) che possono anche essere superiori a 1.

EN The Kundt's tube (UNI EN ISO 10534-2) detects values between 0 and 1 i.e. between 0% and 100%, not comparable with the values detected in the reverberation room (UNI EN ISO 354) which can also be higher than 1.

F Le tube de Kundt (UNI EN ISO 10534-2) permet de relever des valeurs comprises entre 0 et 1, soit entre 0% et 100%. Ces valeurs ne peuvent pas être comparées aux valeurs relevées en chambre réverbérante (UNI EN ISO 354), qui peuvent aller au-delà de 1.

D Das Kundt'sche Rohr (UNI EN ISO 10534-2) ermöglicht die Ermittlung von Werten zwischen 0 und 1, also zwischen 0% und 100% die nicht mit den Werten vergleichbar sind, die in Hallräumen gemessen werden (UNI EN ISO 354). Diese können auch höher als 1 sein.

E Con el tubo de Kundt (UNI EN ISO 10534-2) se logran detectar valores de entre 0 y 1 es decir entre 0% y 100%, que no se pueden comparar con los valores detectados en la cámara reverberante (UNI EN ISO 354) que pueden ser también superiores a 1.

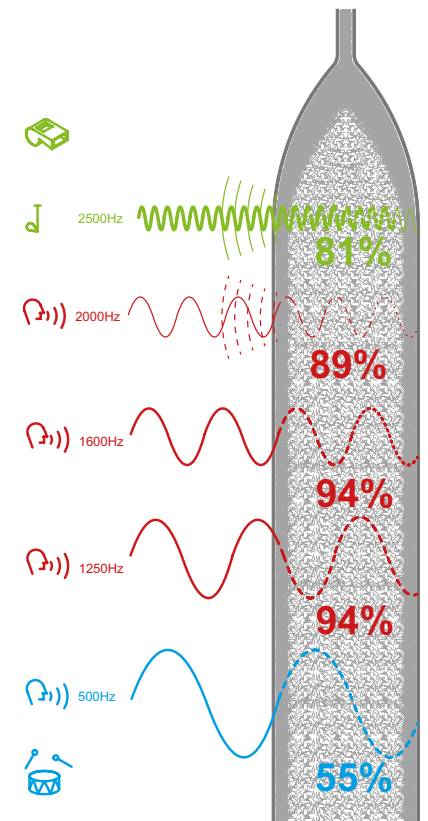

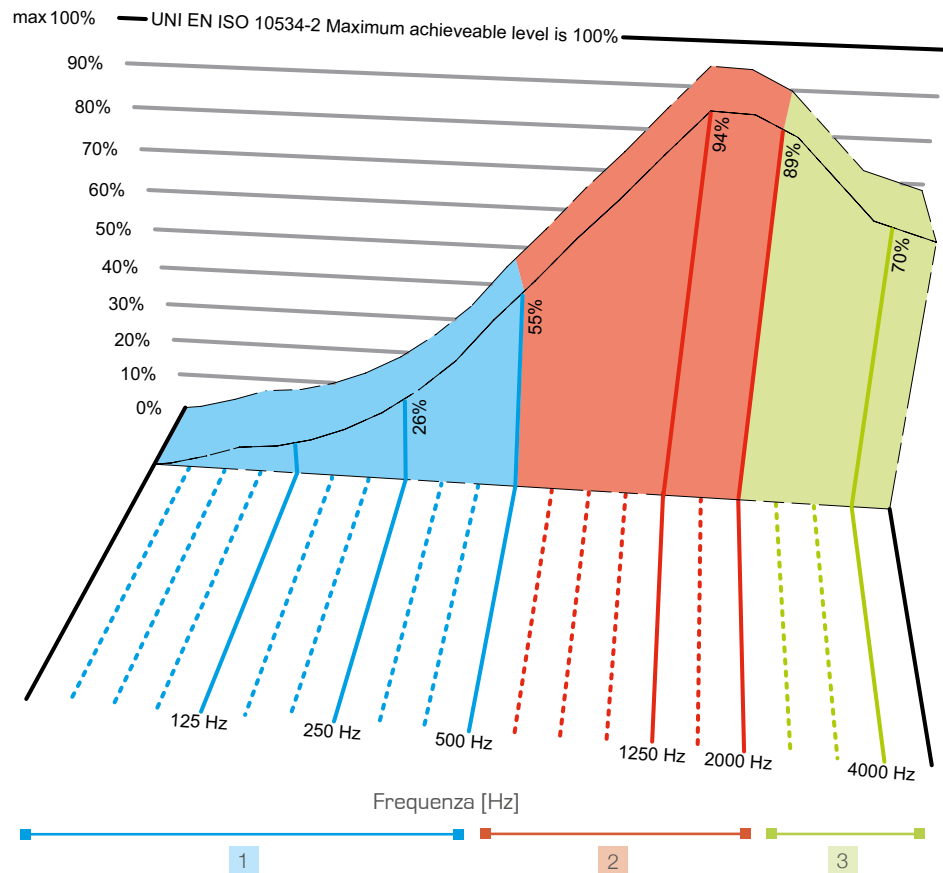

I Massimo livello raggiungibile 100%.
 EN Maximum achievable level is 100%.
 F Niveau maximum possible: 100%.
 D Erreichbares Höchstniveau 100%.
 E Nivel máximo alcanzable 100%.

I Il grafico e l'immagine mostrano come i pannelli acustici, che utilizzano la tecnologia Snowsound®, incidono sull'acustica di un ambiente:

- 1 nonostante lo spessore ridotto assorbono relativamente bene le basse frequenze (sotto i 500 Hz), quelle che caratterizzano i suoni cupi normalmente più difficili da smorzare;
- 2 assorbono molto bene le medie frequenze (tra i 500 e i 2.000 Hz), quelle tipiche della voce umana ed in genere di tutti gli ambienti lavorativi;
- 3 tendono a riflettere, assorbendo gradatamente meno le alte frequenze (sopra i 2.000 Hz), quelle che per loro natura vengono già in gran parte assorbite dalle pareti, dagli elementi d'arredo e dalla presenza stessa delle persone.
 Si ottiene così un naturale complessivo bilanciamento dei suoni nell'ambiente.

EN The graphics and image show how acoustic panels, using Snowsound® technology, affect the acoustics of a room:

- 1 notwithstanding the reduced thickness they do relatively well in absorbing the low frequencies (below 500 Hz), those that characterise deep sounds that are normally more difficult to dampen;
- 2 they absorb very well the midrange frequencies (between 500 and 2,000 Hz), those typical of the human voice and generally in all workplaces;
- 3 they tend to reflect, gradually absorbing less of the high frequencies (above 2,000 Hz), those which by their nature are already in large part absorbed by the walls, the furnishings and by the very presence of people.
 The result thus obtained is a comprehensive, natural balance of sounds in the environment.

F Le graphique et l'image montrent comment les panneaux acoustiques qui utilisent la technologie Snowsound® influencent l'acoustique d'une ambiance:

- 1 malgré l'épaisseur réduite ils absorbent relativement bien les basses fréquences (au-dessous de 500 Hz), c'est-à-dire les fréquences qui caractérisent les sons graves normalement difficiles à contrôler;
- 2 ils absorbent très bien les fréquences moyennes (entre 500 et 2000 Hz), les fréquences typiques de la voix humaines et en général des ambiances de travail;
- 3 ils tendent à réfléchir en absorbant graduellement moins les hautes fréquences (au-dessus de 2000 Hz), les fréquences qu'en réalité sont essentiellement absorbées par les parois, par les éléments d'ameublement et la présence des personnes.
 Il est ainsi possible d'obtenir un équilibre complet des sons dans l'environnement.

D Die Grafik und das Bild zeigen wie sich die schallabsorbierende Paneele mit ihrer Snowsound® Technologie auf die Akustik eines Raumes auswirken:

- 1 trotz der geringen Stärke können die niedrigen Frequenzbereiche verhältnismässig gut aufgenommen werden (unter 500 Hz); Bässe welche vor allem die dumpfen Töne kennzeichnen und normalerweise sehr schwer zu dämpfen sind;
- 2 die Paneele zeigen auch eine sehr gute Absorption in den mittleren Frequenzbereichen (zwischen 500 und 2000 Hz), welche typisch für die menschliche Stimme und allgemeine Arbeitsbereiche sind;
- 3 die Paneele nehmen stufenweise weniger Schall in den hohen Frequenzbereichen auf (über 2000 Hz); Töne welche von Natur aus schon zum großen Teil von den Wänden, den Einrichtungsgegenständen und anwesenden Personen absorbiert werden.
 Als Resultat erhält man ein natürliches Gleichgewicht der Raumakustik.

E El gráfico y la imagen muestran cómo los paneles acústicos, que utilizan la tecnología Snowsound®, inciden en la acústica de un ambiente:

- 1 a pesar del reducido espesor absorben relativamente bien las bajas frecuencias (por debajo de 500 Hz), las que caracterizan los sonidos graves más difíciles de atenuar;
- 2 absorben muy bien las medias frecuencias (de 500 a 2000 Hz), típicas de la voz humana y en general de todos los ambientes laborales;
- 3 tienden a reflejar, absorbiendo gradualmente menos las altas frecuencias (por encima de 2000 Hz), las que por su naturaleza ya son en gran parte absorbidas por las paredes, los elementos de mobiliario y por la propia presencia de las personas.
 Se obtiene así un equilibrio global natural de sonidos en el ambiente.

Acoustic performance “A CLASS”

I I pannelli Snowsound sono stati testati in camera riverberante secondo la norma UNI EN ISO 354 ottenendo la “Classe di Assorbimento Acustico A” in accordo con la norma UNI EN ISO 11654.

EN Snowsound panels were tested in a reverberation room according to UNI EN ISO 354 standards obtaining “Class A sound absorption” to UNI EN ISO 11654 standards.

F Les panneaux Snowsound ont fait l’objet de tests en chambre réverbérante conformément à la norme UNI EN ISO 354, obtenant la “classe d’absorption acoustique A” selon la norme UNI EN ISO 11654.

D Die Snowsound Paneele wurden gemäß der Norm UNI EN ISO 354 in einem Hallraum getestet. Sie erhielten gemäß der Norm UNI EN ISO 11654 die Klassifizierung “Schallabsorption A”.

E Los paneles Snowsound se probaron en cámara reverberante conformemente a la norma UNI EN ISO 354 consiguiendo la “Clase A de Absorción Acústica” en virtud de la norma UNI EN ISO 11654.

ANDAMENTO DEL COEFFICIENTE DI ASSORBIMENTO ACUSTICO “ α_s ” PER TERZI D’OTTAVA
ONE-THIRD OCTAVE SOUND ABSORPTION COEFFICIENT CURVE “ α_s ”

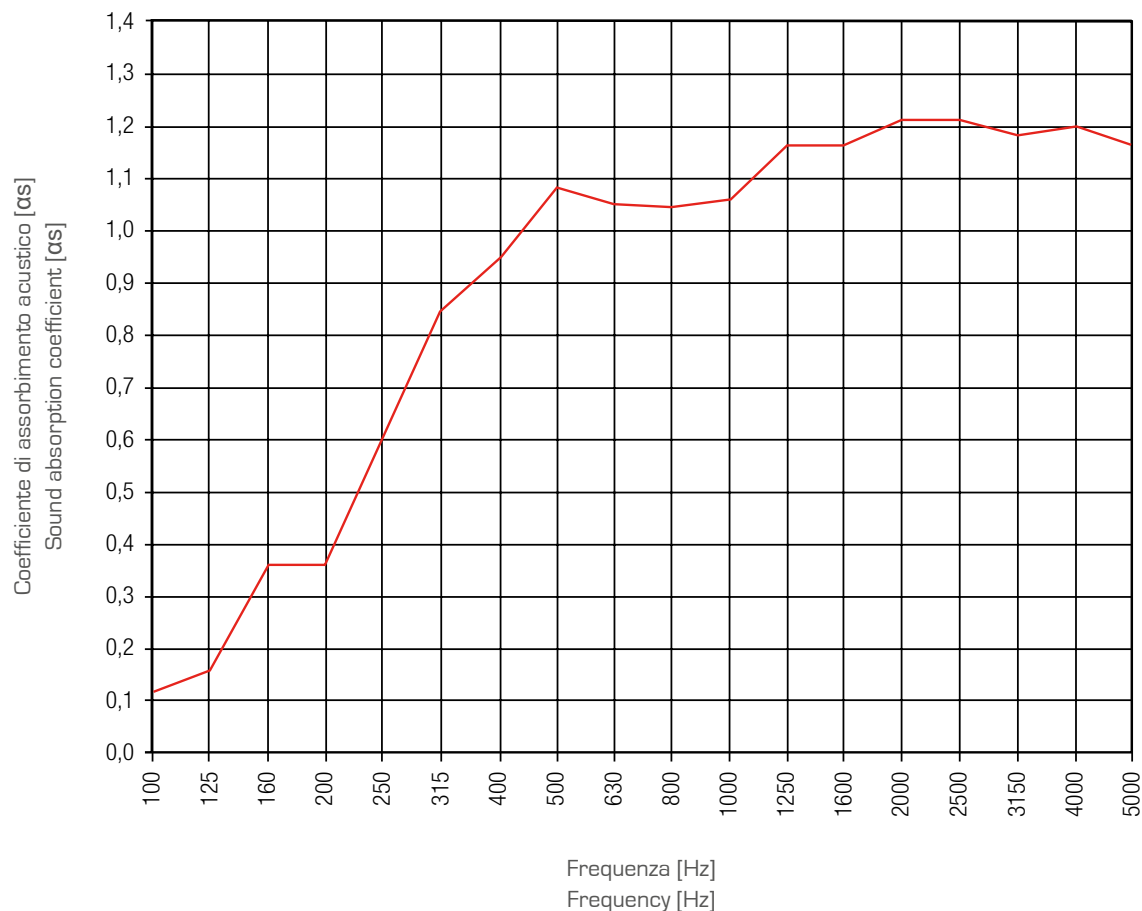

I Misura dell’assorbimento acustico in camera riverberante UNI EN ISO 354 (pannelli Mitesco/Snowsound® installati accostati e con intercapedine d’aria posteriore di 200 mm).

EN UNI EN ISO 354 measures sound-absorbing power in a reverberation room (Mitesco/Snowsound® panels installed side by side and with an 200 mm rear air space).

Decibels' reduction



I La tecnologia Snowsound è stata testata nella camera semianecoica dell'Università di Ferrara per misurarne l'abbattimento acustico in accordo con la norma ISO 10053. Le misurazioni, effettuate con diverse configurazioni, hanno evidenziato le notevoli capacità di attenuazione acustica di Snowsound, registrando le performance alle diverse frequenze.

I risultati dei test rappresentano un ulteriore importante strumento di progettazione messo a disposizione dei professionisti del settore.

EN Snowsound technology was tested in the semi-anechoic chamber at the University of Ferrara to measure sound attenuation according to the ISO 10053 standard. The measurements were conducted with a variety of configurations and demonstrate Snowsound significant capacity for sound attenuation. Performance was recorded at the various frequencies.

The results of the tests represent another important design tool available to industry professionals.

F La technologie Snowsound a été testée dans la chambre semi-anéchoïque de l'Université de Ferrare pour mesurer son abattement acoustique conformément à la norme ISO 10053. Les mesures, effectuées avec différentes configurations, ont mis en évidence les considérables capacités d'atténuation acoustique de Snowsound, en enregistrant les performances aux différentes fréquences. Les résultats des tests sont un important outil supplémentaire de projet pour les professionnels de ce secteur.

D Die Snowsound-Technologie wurde in einem semi-reflexionsarmen Raum der Universität von Ferrara getestet, um die Schalldämpfung entsprechend der ISO-Norm 10053 zu messen. Die mit verschiedenen Konfigurationen durchgeführten Messungen zeigen die bedeutenden schalldämpfenden Eigenschaften von Snowsound, indem die Leistung bei verschiedenen Frequenzen erfasst wurde. Die Ergebnisse dieser Tests sind ein weiteres wichtiges Planungsinstrument, das den Experten der Branche zur Verfügung steht.

E La tecnología Snowsound se probó en la cámara semianecoica de la Universidad de Ferrara para medir su atenuación acústica conforme a la norma ISO 10053. La mediciones, que se llevaron a cabo con diferentes configuraciones, demostraron las notables capacidades de atenuación acústica de Snowsound, registrando las prestaciones con las distintas frecuencias. Los resultados de las pruebas son otra importante herramienta más para el diseño de proyectos que se ofrece a los profesionales del sector.

100% sound absorbing

I L'assenza di cornici rende le superfici dei pannelli Snowsound completamente fonoassorbenti. Tutta la superficie è da considerarsi utile ai fini della correzione acustica. Nessuna parte del pannello è coperta da strutture in altro materiale che possano ostacolare la fonoassorbenza o riflettere parte del suono. I pannelli hanno le stesse caratteristiche estetiche, acustiche e funzionali da entrambi i lati.

EN The frameless design gives Snowsound panels a completely sound absorbing surface. The entire surface functions as acoustic correction; no other material is present to hinder its sound-absorbency or reflect part of the sound. The panels have the same aesthetic, acoustic and functional characteristics on both sides.

D Durch das rahmenlose Design haben die Snowsound-Paneele eine vollständig schallabsorbierende Oberfläche. Die gesamte Oberfläche ist akustisch wirksam, da kein anderes Material vorhanden ist, das die Schallabsorption hindern oder den Schall teilweise reflektieren könnte. Die Paneele haben auf beiden Seiten die gleichen Eigenschaften hinsichtlich ihrer Akustik, Funktion und Ästhetik.

F L'absence de cadres rend les surfaces des panneaux Snowsound complètement phono-absorbantes. Toute la surface est utile à la correction acoustique, aucune partie du panneau n'est couverte par des structures d'autres matériaux qui pourraient empêcher la phono-absorbance ou réfléchir une partie du son. Les caractéristiques esthétiques, acoustiques et fonctionnelles sont identiques pour chacun des deux côtés.

E Las superficies de los paneles Snowsound son totalmente fonoabsorbentes porque no llevan marcos. Toda la superficie debe considerarse útil en cuanto a corrección acústica porque ninguna parte del panel queda cubierta por estructuras de otros materiales que pueden dificultar la absorción acústica o reflejar parte del sonido. Los paneles tienen las mismas características estéticas, acústicas y funcionales en ambas caras.

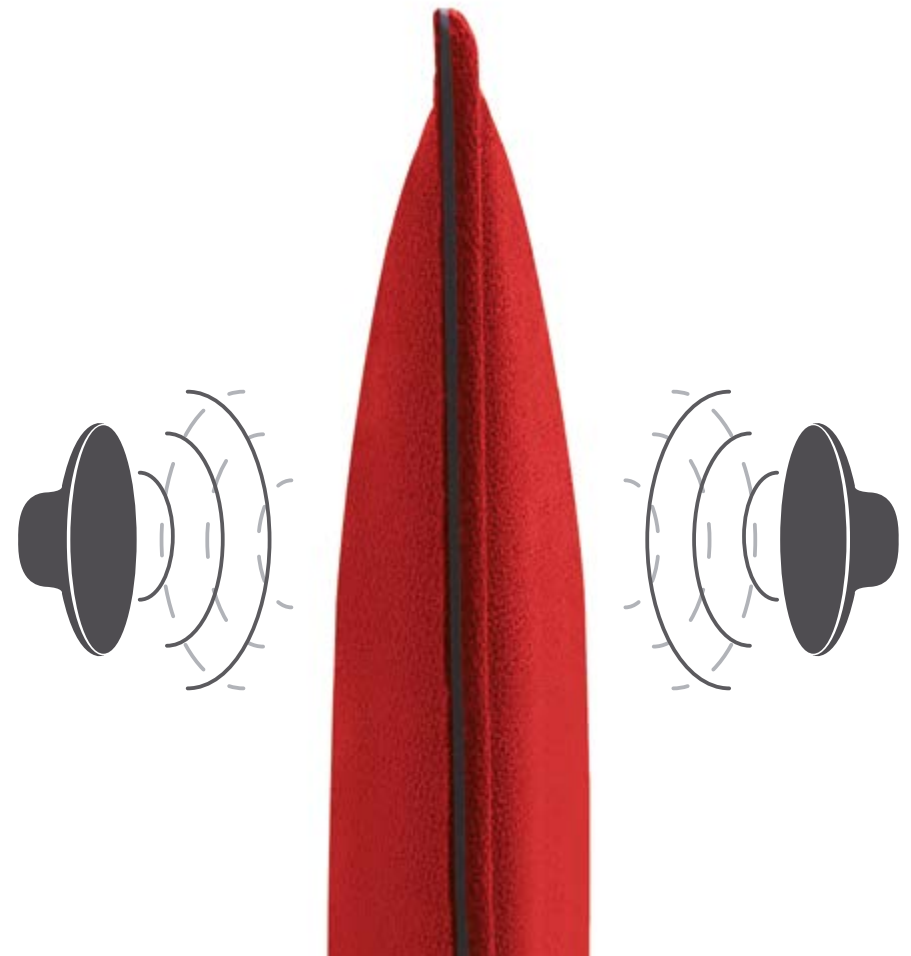

Hygiene & maintenance



I L'assenza di intercapedini tra tessuto e materiale fono-assorbente e l'assenza di cavità riducono notevolmente la possibilità di accumulare polveri, pollini o di ospitare insetti. La superficie continua del pannello è facilmente pulibile con detergenti specifici.

EN The absence of an airspace or cavity between the fabric and the sound-absorbing material significantly decreases the accumulation of dust, pollen or insect infestation. The seamless surface of the panel is easy to clean with appropriate detergents.

F L'absence de lame d'air entre le tissu et le matériau phono-absorbant conjuguée à l'absence de cavité réduit nettement la probabilité d'accumuler poussières et pollens et d'abriter des insectes. La surface continue du panneau est aisément lavable au moyen de détergents adéquats.

D Da kein Zwischenraum zwischen Stoff und schalldämpfendem Material besteht und es keine Hohlräume gibt, ist eine Ablagerung von Staub, Pollen oder Insekten sehr unwahrscheinlich. Die glatte Oberfläche des Paneels vereinfacht die Reinigung mit Spezialprodukten.

E Puesto que no hay espacios ni huecos entre el tejido y el material acústico absorbente, la posibilidad de que se acumule polvo, polen o se alojen insectos es muy limitada. La superficie continua del panel se puede limpiar fácilmente con detergentes específicos.

Strong, light & thin



I La densità differenziata di Snowsound non solo ottimizza la resa acustica dei pannelli, ma crea un guscio di protezione superficiale che rende il pannello più robusto e meno soggetto a danneggiamenti, graffi, strappi, sfondamenti tipici dei materiali porosi o fibrosi. La tecnologia Snowsound permette di produrre pannelli robusti ma estremamente sottili, leggeri e maneggevoli, con un peso medio di 3,4 Kg per m².

EN The variable density of Snowsound not only optimises the acoustic performance of the panels, but also creates a superficial protection shell which makes the panel more robust and less subject to damage, scratching, tears or other damages typical of porous or fibrous materials. Snowsound technology produces durable yet extremely thin, lightweight and easy to handle panels, averaging 3.4 Kg per m².

F La densité variable de Snowsound ne se contente pas d'optimiser le rendement acoustique des panneaux; elle crée une coque de protection superficielle qui rend le panneau plus robuste et moins vulnérable à la dégradation, aux rayures, déchirures et perforations fréquemment associées aux matériaux poreux ou fibreux. La technologie Snowsound permet de produire des panneaux robustes et néanmoins de très faible épaisseur, légers et maniables, d'un poids moyen de 3,4 Kg par m².

D Die unterschiedliche Dichte von Snowsound optimiert nicht nur die Akustikleistung der Paneele, sondern schafft auch eine Schutzhülle, durch die das Paneel robuster und weniger anfällig für Beschädigungen, Kratzer, Risse und Verformungen wird, die typisch für poröses Fasermaterial sind. Die Snowsound-Technologie ermöglicht die Herstellung von robusten, aber gleichzeitig schlanken, leichten und handlichen Paneelen, die ein Durchschnittsgewicht von 3,4 Kg pro qm haben.

E Las diferentes densidades de Snowsound perfeccionan la acústica de los paneles, pero también crean una envoltura de protección superficial; el panel resulta más robusto frente a posibles daños, rayas, rasgones, abolladuras típicas de los materiales porosos o fibrosos. Con la tecnología Snowsound se pueden fabricar paneles robustos pero sumamente delgados, ligeros y transportables, con un peso medio de 3,4 Kg por m².

Eco-friendly



Vedi pag.18
See page 18



I Nella progettazione del pannello ci si è posti l'obiettivo di ottenere l'integrale riciclabilità del prodotto a fine vita, in modo semplice e rapido. Per questo motivo i pannelli sono stati realizzati interamente in poliestere, quindi monomaterici e **riciclabili al 100%** senza necessità di dover separare il tessuto esterno dal materiale fonoassorbente interno. Anche tutta la componentistica in plastica o in metallo è monomaterica e facilmente disassemblabile, consentendo così il riciclaggio di tutto il prodotto al 100%. L'utilizzo di materiali e lavorazioni di alta qualità permettono inoltre di allungare la vita del prodotto con conseguente minor consumo di materiali ed energia.

Il materiale fonoassorbente interno è prodotto con materiale riciclato fino al 30%. I pannelli non contengono feltri o altri materiali di origine organica difficilmente riciclabili.

EN In the designing of the panel the objective set was to obtain the entire recyclability of the product at the end of its useful life, in a manner both simple and rapid. For this reason, the panels have been made entirely of polyester; therefore they are "single material" and **100% recyclable** without separating the outer fabric from the sound-absorbing inner material. Also, all components are made of single materials, plastic or metal and can be easily disassembled, thus recycling the whole product at 100%. The use of high quality materials and processing, moreover, makes it possible to obtain longer product usage life, resulting in reduced consumption of materials and energy. The internal sound-absorbing material is produced with up to 30% recycled material. The panels do not contain felt or other organic materials which are difficult to recycle.

D Das Ziel bei der Produktentwicklung war es die gänzliche Wiederverwertbarkeit der Paneele nach dem Ende der Nutzungsdauer sicherzustellen. Aus diesem Grund werden die Paneele vollständig aus Polyester hergestellt, d.h. aus nur einem einzigen Material, welches zu **100% recyclebar** ist. Die besondere Bauweise ermöglicht eine Wiederverwertung ohne den Dekorstoff von dem schallabsorbierenden Innenmaterial zu trennen. Sämtliche anderen Komponenten des Systems sind aus Kunststoff oder Metall, wodurch ebenfalls eine 100% Wiederverwertung möglich ist. Durch die Verwendung hochwertiger Materialien und Verarbeitungsmethoden wird, mit einem geringen Energie- und Materialaufwand, ein besonders langlebiges Produkt hergestellt. Das interne schalldämpfende Material wird bis zu 30% aus recyceltem Material hergestellt. Die Paneele enthalten keinen Filz oder andere schwer wiederverwertbare organische Stoffe.

F Dans le projet du panneau on a cherché à obtenir la possibilité de recycler entièrement le produit à la fin de sa vie, d'une manière simple et rapide. Pour ces raisons, les panneaux ont été réalisés entièrement en polyester, un seul matériel et **recyclable au 100%** sans nécessité de séparer le tissu externe du matériel phono-absorbant interne. Les éléments en plastique aussi ou en métal sont en un seul matériel et par conséquent il est très facile de les désassembler, en permettant ainsi un recyclage complet du produit à 100%. L'emploi des matériels et des techniques d'usage de haut de gamme permettent par la suite d'allonger la vie du produit avec une conséquente réduction de la consommation des matériels et d'énergie.

Le matériau phono-absorbant interne contient jusqu'à 30% de matériau recyclé.

Les panneaux ne contiennent pas de feutre ni de matériau organique difficilement recyclable.

E En el diseño del panel se decidió de obtener la integral reciclabilidad del producto al final de su vida útil, de manera sencilla y rápida. Por este motivo los paneles han sido realizados en poliéster, por lo tanto con un único material y **reciclables al 100%**, sin necesidad de tener que separar el tejido externo del material fonoabsorbente interno. Asimismo, todos los componentes de plástico o de metal son de un único material y fácilmente desmontables, permitiendo así su reciclado al 100%. El uso de materiales y elaboraciones de alta calidad permiten también obtener una prolongación de la vida útil del producto con un consiguiente menor consumo de materiales y energía. El material acústico absorbente interior se fabrica con hasta un 30% de material reciclado. Los paneles no contienen fieltro ni otros materiales de origen orgánico que resulta difícil reciclar.

Extreme conditions



-20°C



+70°C

I Per simulare l'influenza del ciclo delle stagioni sugli ambienti interni, abbiamo sottoposto i pannelli Snowsound ad un ciclo di condizioni climatiche estreme secondo la norma ISO 9142, che prevede un test in camera climatica con temperature da -20°C (-4°F) fino a +70°C (+158°F) e umidità fino al 90%.

EN To simulate the influence of the seasons on indoor environments, Snowsound panels are subjected to a cycle of extreme weather conditions according to ISO 9142 standards in a climate chamber at -20°C (-4°F) to +70°C (+158°F) and humidity up to 90%.

F Pour simuler l'influence du cycle des saisons en intérieur, nous avons soumis les panneaux Snowsound à un cycle de conditions climatiques extrêmes conformément à la norme ISO 9142, qui prévoit un test en chambre climatique avec des températures allant de -20°C (-4°F) jusqu'à +70°C (+158°F) avec une humidité jusqu'à 90%.

D Um den Einfluss der Jahreszeiten auf Innenbereiche zu simulieren, werden Snowsound-Paneele gemäß der ISO-Norm 9142 in einer Klimakammer einem Zyklus von extremen Wetterbedingungen bei Temperaturen von -20°C (-4°F) bis zu +70°C (+158°F) und einer Feuchtigkeit von bis zu 90% ausgesetzt.

E Para simular la influencia del ciclo de las temporadas en los ambientes internos, hemos sometido los paneles Snowsound a un ciclo de condiciones climáticas extremas conforme a la norma ISO 9142, que contempla una prueba en cámara climática con temperaturas desde -20°C (-4°F) hasta +70°C (+158°F) y humedad hasta el 90%.



Giotto

Sezgin
Aksu



I Giotto è un pannello fonoassorbente Snowsound dalla forma circolare proposto in due versioni: Giotto Ceiling con sistema di appendimento a soffitto mediante cavi regolabili in altezza e Giotto Wall, dotato di un particolare supporto a parete in acciaio che dal foro centrale sostiene il pannello inserito ad incastro.

EN Giotto is a Snowsound sound-absorbing round panel available in two versions: Giotto Ceiling (suspended from the ceiling via height adjustable cables) and Giotto Wall (wall mounting thanks to a specific steel support, which sustains the panel from its central hole).

D Giotto ist ein schallabsorbierendes Snowsound-Paneel mit runder Form, das in zwei Versionen angeboten wird: Giotto Ceiling, das über ein System mit höhenverstellbaren Stahlseilen an der Decke angebracht wird, und Giotto Wall, das über eine spezielle Wandhalterung aus Stahl verfügt, in die die mittlere Öffnung des Paneel eingehängt wird.

F Giotto est un panneau phono-absorbant Snowsound à la forme circulaire proposé en deux versions : Giotto Ceiling avec suspension au plafond par des câbles réglables en hauteur et Giotto Wall, muni d'un support mural particulier en acier qui soutient le panneau fixé par emboîtement à partir d'une ouverture centrale.

E Giotto es un panel fonoabsorbente Snowsound de forma circular con dos versiones: Giotto Ceiling con sistema para colgarlo del techo mediante cables que ajustan la altura y Giotto Wall, equipado con un soporte mural especial de acero que del agujero central sostiene el panel encastrable.

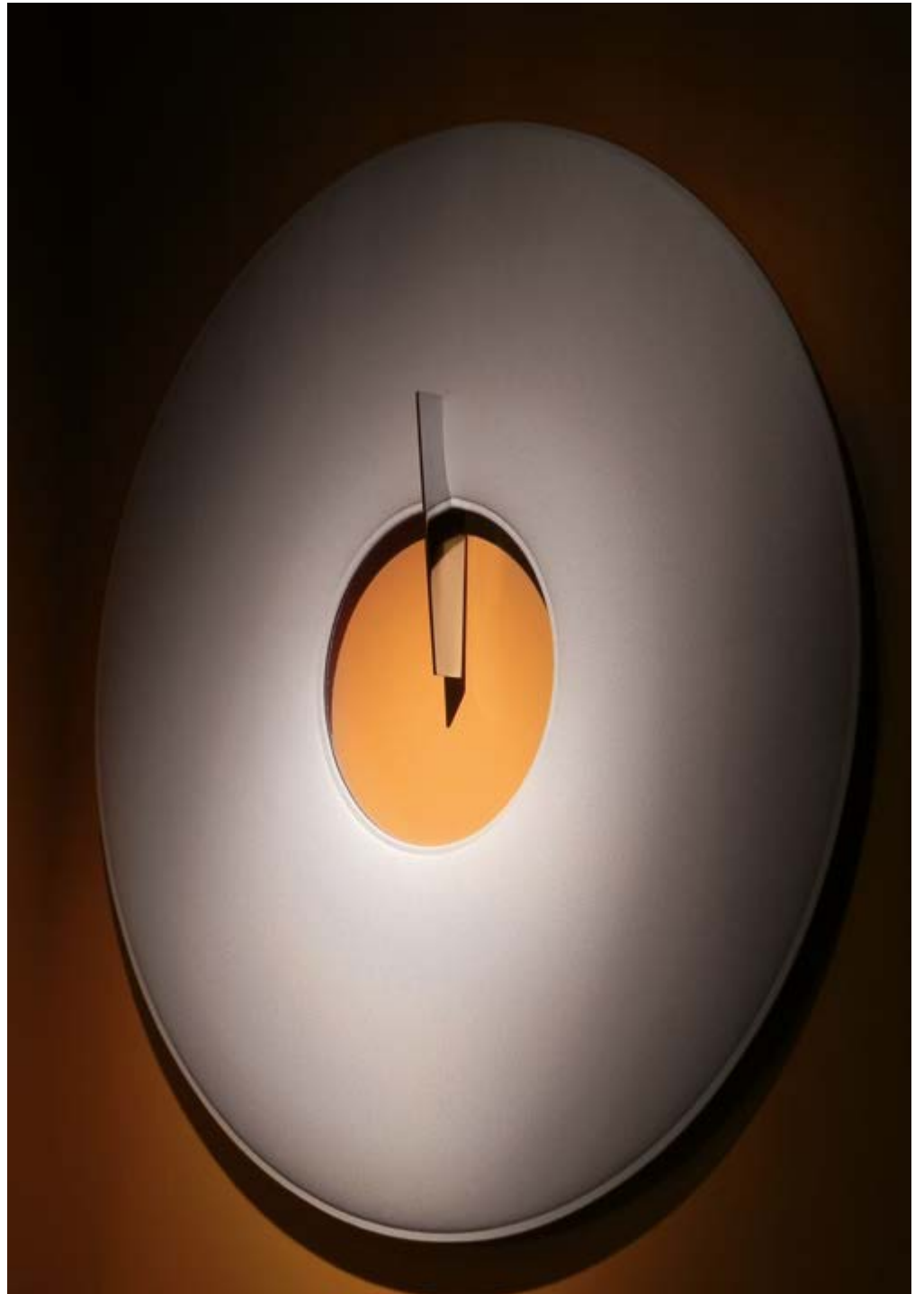

Giotto lux

Sezgin
Aksu

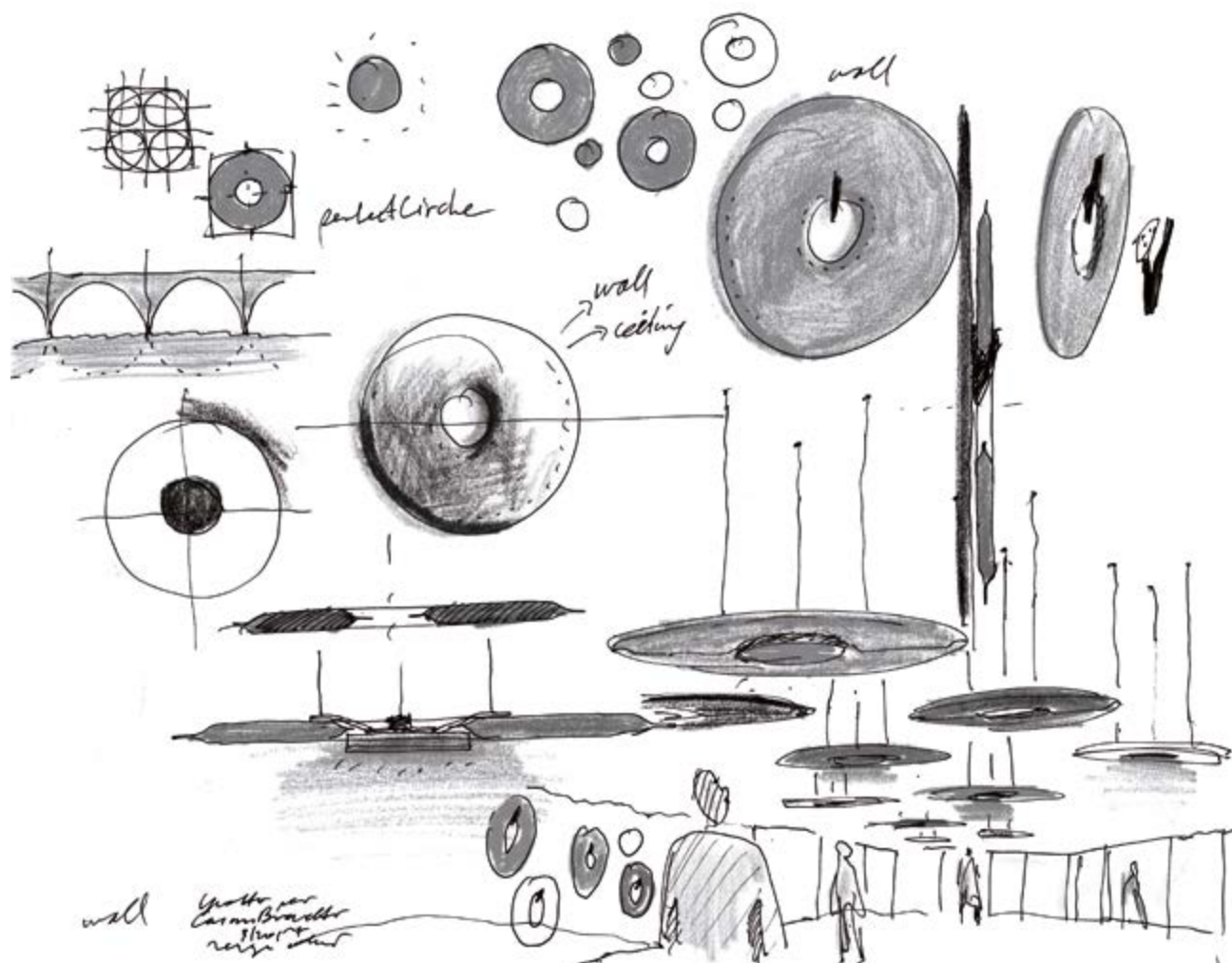

I Giotto lux è un pannello fonoassorbente Snowsound dalla forma circolare al centro del quale è alloggiato un corpo illuminante in metallo verniciato con sorgente luminosa a luce LED, protetta da un diffusore in polietilene satinato bianco opaco che consente di ottenere un'emissione omogenea della luce.

EN Giotto lux is a Snowsound sound-absorbing round panel, which accommodates in its centre a painted steel lighting element with LED technology covered by a satin-finished polyethylene diffuser that allows homogeneous emission of light.

F Giotto lux est un panneau phono-absorbant Snowsound de forme circulaire au centre duquel se trouve un élément d'éclairage en métal peint avec source de lumière LED, protégée par un diffuseur en polyéthylène satiné blanc mat, qui permet de créer une lumière homogène.

D Giotto lux ist ein schallabsorbierendes Snowsound-Panel mit runder Form, in dessen Mitte ein Leuchtkörper aus lackiertem Metall mit LED- Licht angebracht ist. Die Leuchtenabdeckung aus weißem, satiniertem Polyethylen ermöglicht eine gleichmäßige Lichtverteilung.

E Giotto lux es un panel fonoabsorbente Snowsound de forma circular con un centro iluminante de metal barnizado con fuente luminosa de luz LED, protegida por un difusor de polietileno satinado blanco opaco que ofrece una emisión homogénea de luz.



I I cavi di appendimento a soffitto permettono la regolazione in altezza. Il risultato è un grande "lampadario", un unico oggetto d'arredo che risolve due esigenze sensoriali: illumina e rende confortevole acusticamente gli ambienti.

EN Adjustable hanging cables allow height regulation. The result is a large "light fixture," a single decorative element that meets two sensorial needs at the same time: it offers light and provides acoustic comfort to interiors.

F Les câbles de suspension au plafond permettent un réglage en hauteur. Le résultat est un grand "lustre", un objet unique d'ameublement qui répond à deux exigences sensorielles : éclairer et assurer le confort acoustique des intérieurs.

D Die Stahlseile für die Deckenmontage können in der Höhe verstellt werden. Das Ergebnis ist ein großer "Kronleuchter", ein Einrichtungsobjekt, das zwei Bedürfnisse unserer Sinne gleichzeitig befriedigt: Der Raum wird beleuchtet und gleichzeitig akustischer Komfort geboten.

E Se logra ajustar la altura trámite los cables que se emplean para colgarlo del techo. Acaba siendo una "lámpara de techo" muy grande. Con un objeto de decoración único se atiende a dos necesidades sensoriales: la iluminación y el confort acústico de los ambientes.



Snowfix

Caimi
Lab



I Snowfix è un sistema di fissaggio a parete dei pannelli Snowsound mediante un supporto composto da due componenti in pressofusione di metallo con finitura verniciata o nichel satinata, che si fissano rispettivamente uno sul pannello e l'altro direttamente a parete e si agganciano l'uno all'altro rendendo il pannello fonoassorbente inasportabile.

EN Snowfix is a wall mounting system for Snowsound panels that employs a support made up of two components in die-cast metal, which has been painted or satin-finished in nickel. One plate is fixed to the panel while the other is attached directly to the wall. These two parts work together making the sound-absorbing panel not removable.

F Snowfix est un système de fixation murale pour panneaux Snowsound, qui utilise un support comprenant deux éléments en métal coulé sous pression, peint ou nickel satiné, dont un est fixé sur un panneau et l'autre directement au mur et qui s'accrochent l'un à l'autre faisant en sorte que le panneau phono-absorbant ne puisse pas être enlevé.

D Snowfix ist ein Wandbefestigungssystem für Snowsound-Paneele, bestehend aus zwei lackierten bzw. Matt vernickelten Metallussteile, die auf dem Paneel und an der Wand angebracht werden und ineinander gehakt werden, sodass das schallabsorbierende Paneel fest sitzt.

E Snowfix es un sistema de fijación mural de los paneles Snowsound mediante un soporte que consta de dos componentes de metal moldeados a presión con acabado de barniz o niquel satinado, que se fijan respectivamente uno sobre el panel y el otro directamente en la pared y que se enganchan uno con otro para que el panel fonoabsorbente resulte inamovible.

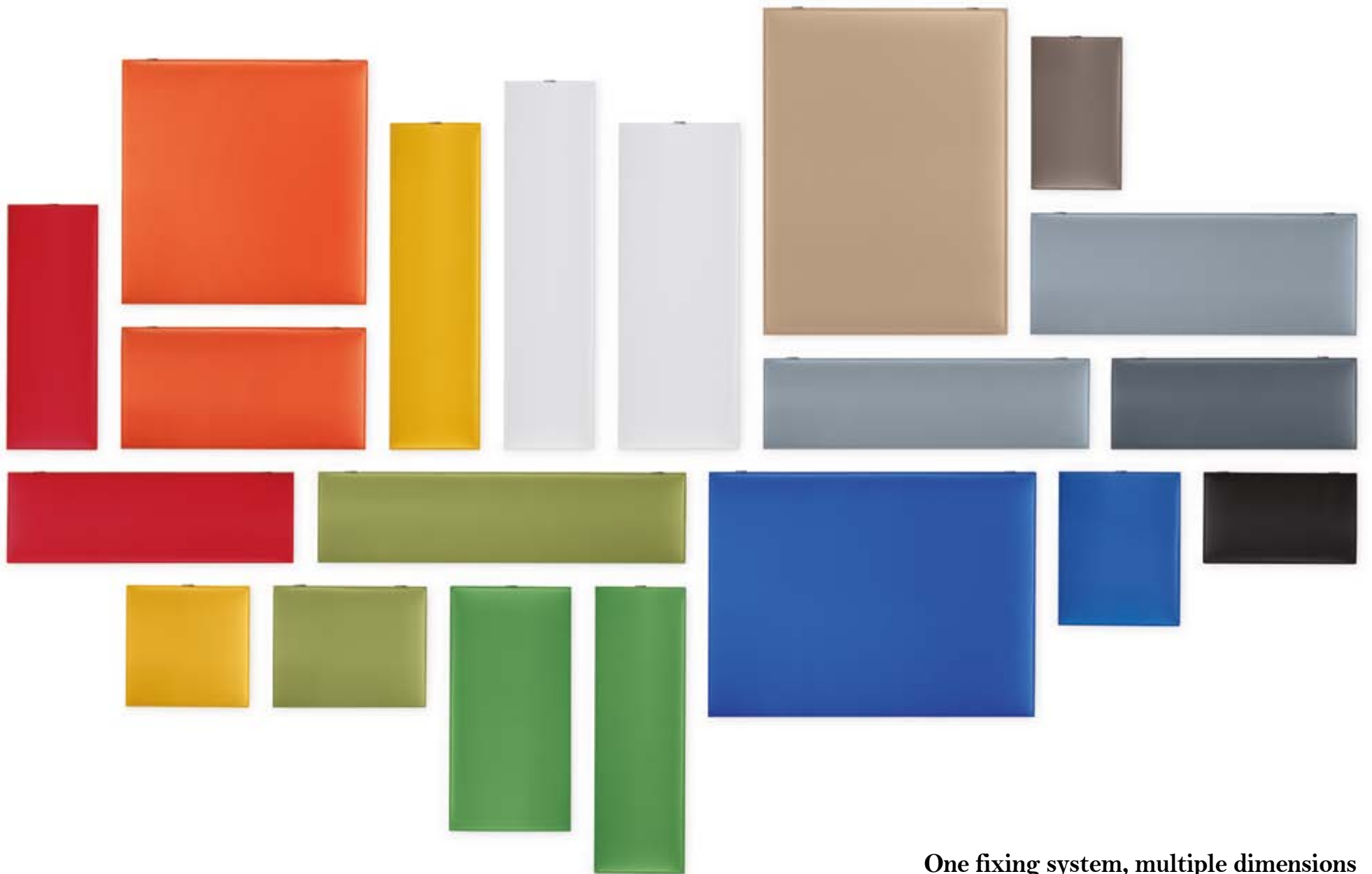

One fixing system, multiple dimensions

Snowsound Technology

Design

Oversize

Caimi
Lab



I Il sistema Oversize è caratterizzato dalle grandi dimensioni dei pannelli fonoassorbenti realizzati con tecnologia Snowsound che possono essere posizionati a parete, a soffitto o a scrivania.

EN The Oversize system is characterised by the large dimensions of the sound-absorbing panels made with Snowsound technology that can be located on the wall, ceiling or on a desk.

F Le système Oversize se caractérise par les grandes dimensions de ses panneaux phono-absorbants réalisés avec la technologie Snowsound, panneaux qui peuvent être placés au mur, au plafond ou sur un bureau.

D Charakteristisch für das System Oversize sind die großen Maße der schallabsorbierenden und mit Snowsound-Technologie hergestellten Paneele, die an der Wand, an der Decke oder am Schreibtisch montiert werden können.

E El sistema Oversize se caracteriza por el gran tamaño de los paneles fono-absorbentes realizados con la tecnología Snowsound que pueden colocarse en la pared, en el techo o en el escritorio.



Snowsound Technology

Design

Oversize lux

Marc
Sadler

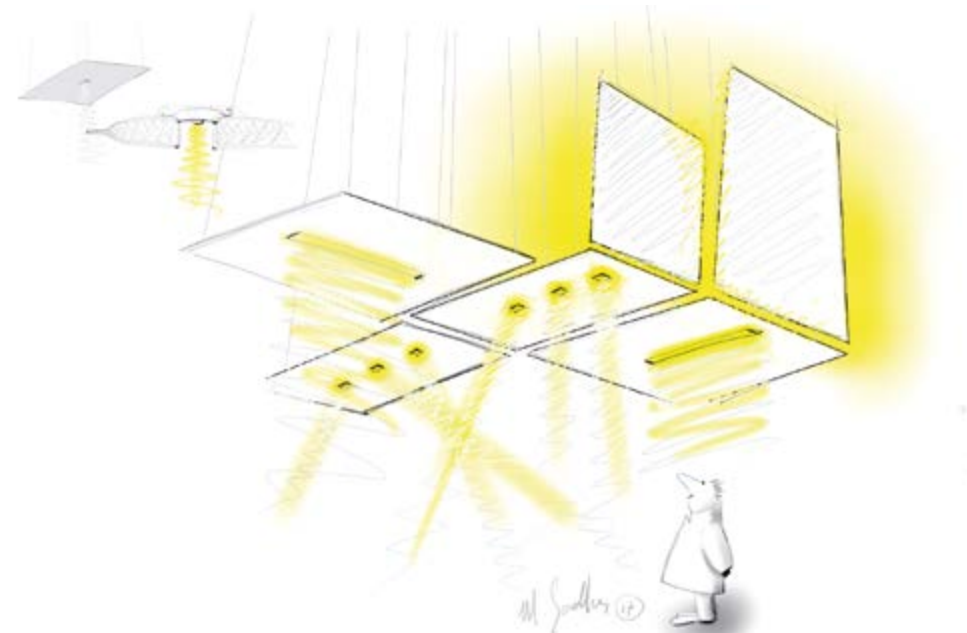

I Oversize lux è un progetto che fonde il concetto d'illuminazione tecnica con la tecnologia fonoassorbente Snowsound. Dall'integrazione di questi aspetti sono nati dei veri e propri componenti architettonici, di grandi dimensioni, con luci LED incassate nei pannelli fonoassorbenti. I cavi di sospensione a soffitto sono regolabili.

EN Oversize lux is a project that brings together the concept of technical lighting with Snowsound sound-absorbing technology. The results of this combination are large architectural elements that incorporate LED lights in sound-absorbing panels. The ceiling suspension cables are adjustable.

F Oversize lux est un projet qui unit le concept d'éclairage technique avec la technologie phono-absorbante Snowsound. A partir de l'intégration de ces deux aspects sont nés de véritables éléments architecturaux de grandes dimensions, avec des lumières à LED encaissées dans les panneaux phono-absorbants. Les câbles de suspension au plafond sont réglables.

D Oversize lux ist ein Projekt, bei dem technische Beleuchtung und schallabsorbierende Snowsound-Technologie miteinander verschmelzen. Aus der Verbindung dieser Elemente sind echte Architekturobjekte von beachtlicher Größe entstanden, deren LED-Lichter in die schalldämpfenden Paneele integriert sind. Die Stahlseile zum Anbringen an die Decke sind verstellbar.

E Oversize lux es un proyecto que fusiona el concepto de iluminación técnica con la tecnología fonoabsorbente Snowsound. Integrando estos ámbitos se crearon verdaderos componentes arquitectónicos, de gran tamaño, con lámparas LED integradas en los paneles fonoabsorbentes. Los cables para colgarlos del techo son ajustables.





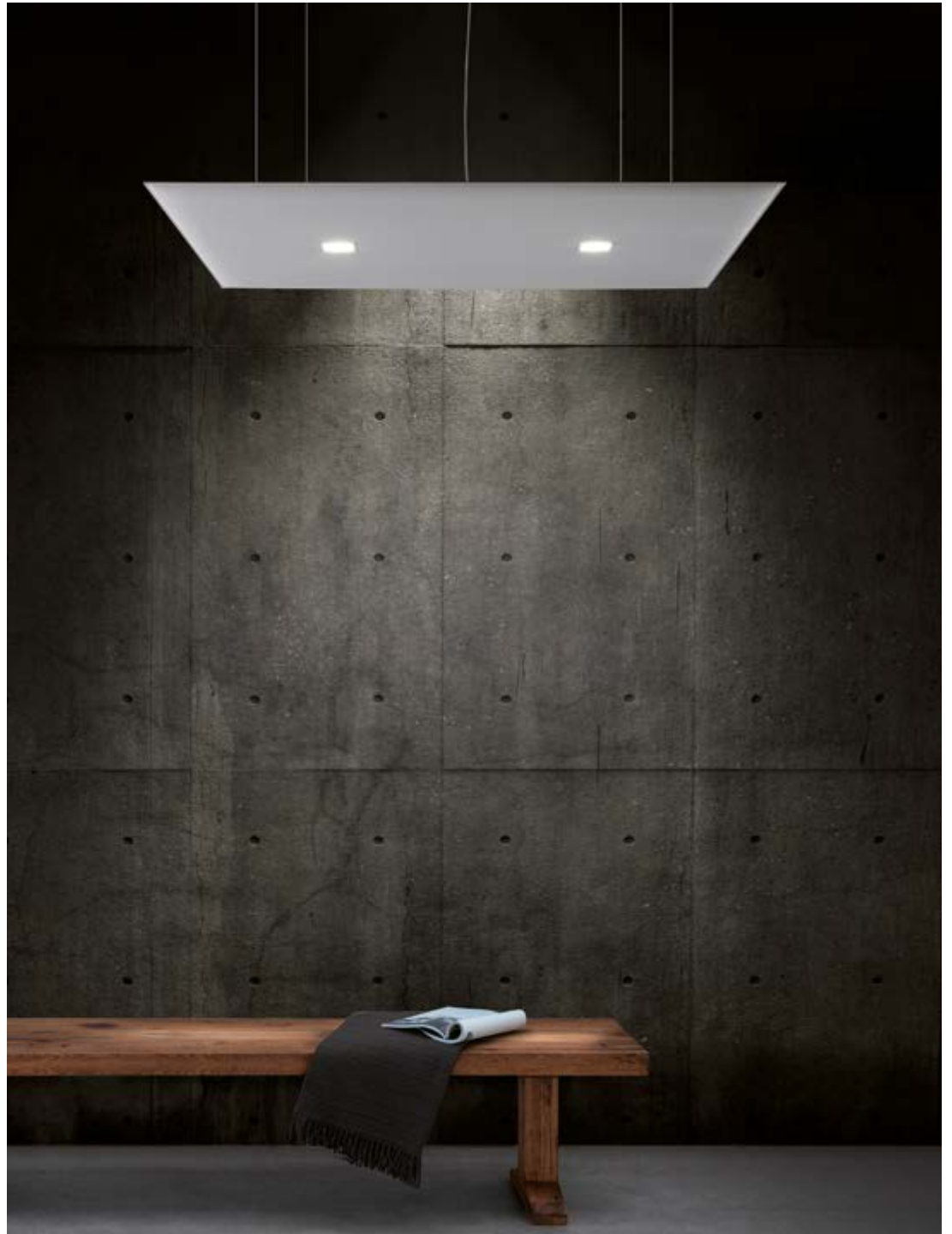
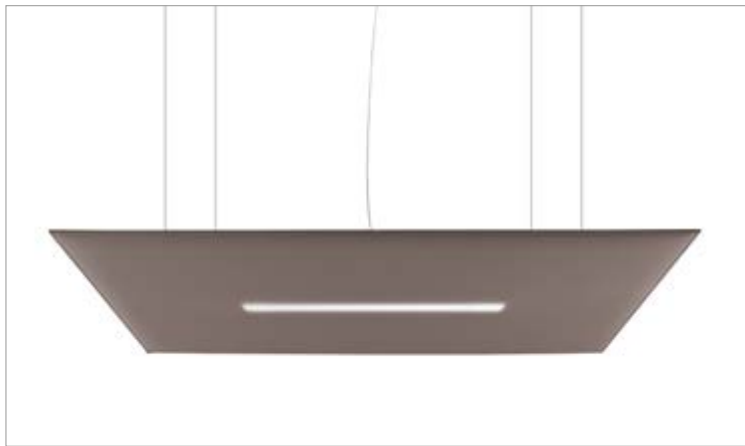

Snowsound Technology

Design

Pli Oversize

Marc
Sadler



I Pli Oversize è un pannello fonoassorbente realizzato con tecnologia Snowsound, sorretto da un cavalletto in acciaio, può essere utilizzato come divisorio all'interno degli ambienti.

EN Pli Oversize is a sound-absorbing Snowsound panel, supported by a steel frame which can be used as a partition to divide space.

F Pli Oversize est un cloison phono-absorbant composé de panneaux Snowsound, soutenu par un chevalet en acier. Elle peut servir de cloison à l'intérieur des pièces.

D Pli Oversize ist ein schallabsorbierender Raumteiler, der aus Snowsound-Paneelen besteht und von Standfüßen aus Stahl gestützt wird. Das Produkt kann auch als Trennwand eingesetzt werden. Es ist möglich mehrere Paneele anhand eines Riemens miteinander zu verbinden.

E Pli Oversize es una mampara fonoabsorbente que está compuesta por paneles Snowsound, sobre un caballete de acero y que se puede emplear como divisorio dentro de diferentes ambientes.

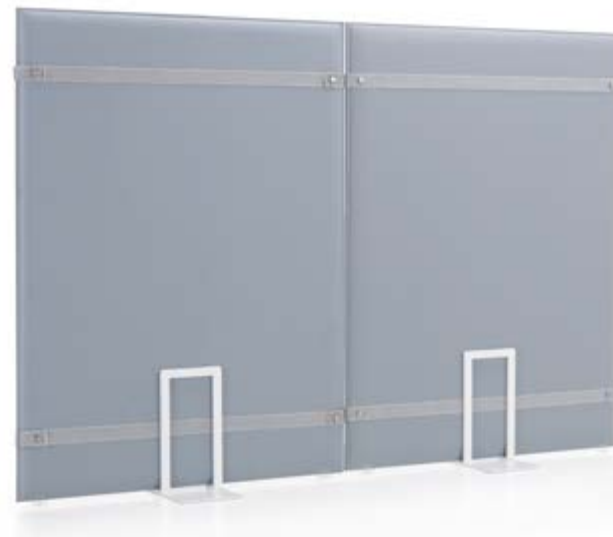
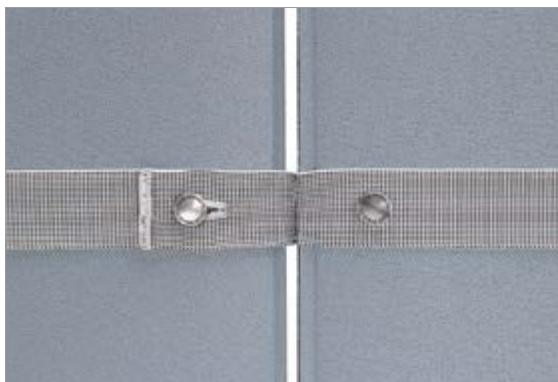

I È possibile unire più pannelli tra loro mediante una cinghia che abbraccia il pannello, dotata di bottoni in acciaio ed occhielli che permettono di ottenere soluzioni lineari, soluzioni a “T”, ad “L” o ad “X”.

EN Several panels can be connected together by a strap, fitted with steel buttons and buttonholes, which wrap around the panel and create linear, “T”, “L” or “X” formations.

F Il est possible d’unir les panneaux entre eux à l’aide d’une courroie qui englobe le panneau, munie de boutons en acier et de boutonnières permettant d’obtenir des solutions linéaires, des solutions en forme de “T”, de “L” ou de “X”.

D Der Riemen umgibt das Paneel und ist mit Stahlknöpfen und Ösen ausgestattet, dank denen lineare Lösungen, sowie “T”-, “L”- oder “X”-förmige Kombinationen realisiert werden können.

E Los paneles se pueden acoplar mediante una correa que los rodea y que lleva botones de acero y ojales para formar soluciones planas, soluciones en “T”, en “L” o en “X”.







Pli

Marc
Sadler



I Pli è un divisorio fonoassorbente composto da pannelli Snowsound, uniti tra loro mediante una cinghia elastica disponibile in 3 finiture. La cinghia abbraccia il pannello ed è dotata di bottoni in acciaio ed occhielli che permettono di ottenere soluzioni lineari, soluzioni a "T", ad "L" o ad "X".

EN Pli is a sound-absorbing partition wall, made up of Snowsound panels joined with elastic bands available in three finishes. The bands embrace the panel and are furnished with steel buttons and O-rings that create linear, "T", "L" or "X" configurations.

F Pli est un cloison phono-absorbant composé de panneaux Snowsound, unis entre eux par une sangle élastique disponible en 3 finitions. La sangle entoure le panneau et elle est munie de boutons en acier et d'œillets qui permettent d'obtenir des solutions linéaires, des solutions en "T", en "L" ou en "X".

D Pli ist eine schallabsorbierende Trennwand, die aus Snowsound-Paneelen besteht, welche durch, in drei Farbvarianten erhältliche, elastische Gurte miteinander verbunden werden. Die Gurte umschließen das Paneel und sind mit Stahlknöpfen und Ösen ausgestattet, dank denen lineare Lösungen, "T", "L"- oder "X"-förmige Kombinationen realisiert werden können.

E Pli es una mampara fonoabsorbente compuesta por paneles Snowsound, enlazados por una correa elástica con tres acabados diferentes. La correa rodea el panel y lleva botones de acero y ojales para formar soluciones planas, soluciones en "T", en "L" o en "X".

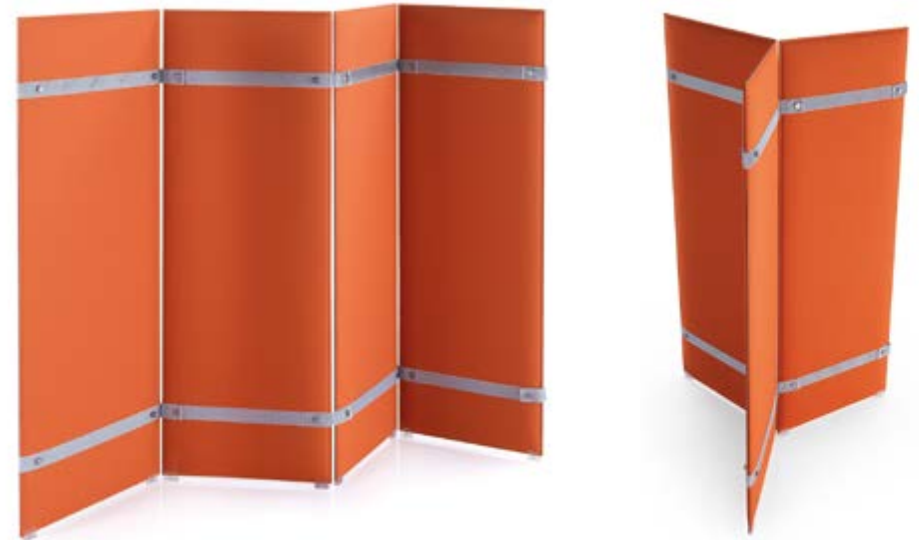

I Pli offre una grande varietà di colori sia per i pannelli che per le cinghie in tessuto, combinabili tra di loro. Il sistema Pli può essere corredato da una base di sostegno in acciaio cromato.

EN Pli offers a large variety of colours for the panels and the fabric bands, to mix and match. The Pli system can be furnished with a chrome-plated steel supporting base.

F Pli offre une grande palette de coloris aussi bien pour les panneaux que pour les sangles en tissu, permettant ainsi de les combiner. Le système Pli peut être équipé d'une base de soutien en acier chromé.

D Pli bietet eine große Auswahl an Farben, sowohl bei den Paneelen als auch bei den Gurten, die sich gut miteinander kombinieren lassen. Das Pli-System kann außerdem mit Standfüßen aus verchromtem Stahl ausgestattet werden.

E Pli ofrece un extensa gama de colores tanto para los paneles como para las correas de tela, para poderlos combinar. Se puede dotar al sistema Pli de una base de apoyo de acero cromado.

Flap

Alberto Meda
Francesco Meda



I Molto più che un pannello fonoassorbente, Flap è un oggetto di design con grande forza estetica e formale che può dar vita ad infinite composizioni con disegni sempre differenti. Un sistema modulare brevettato, innovativo sia per la tecnologia Snowsound applicata, sia per l'idea del pannello inteso come complemento d'arredo che si inserisce con trasversalità in ogni ambiente che necessiti di una correzione acustica.

EN More than just a sound-absorbing panel, Flap is a design piece with considerable aesthetic and formal impact which can create a wide array of compositions with designs that are always new. This patented modular system is completely innovative in the applied Snowsound technology and in the notion of the panel as a furnishing accessory that fits perfectly in any room that requires an acoustic adjustment.

F Flap ne se contente pas d'être un panneau phono-absorbant. Véritable objet design, sa force esthétique et formelle permet une infinité de compositions aux expressions toujours différentes. Le système modulaire breveté est innovant sur deux fronts: la technologie Snowsound d'une part, d'autre part la manière dont le panneau s'inscrit parfaitement dans l'ameublement de tout espace exigeant une correction acoustique.

D Mehr noch als ein schalldämpfendes Paneel ist Flap ein Designgegenstand mit einer unglaublichen formalen Ästhetik, der unendlich viele unterschiedliche Formen annehmen kann. Ein patentiertes modulares System, das dank der zum Einsatz kommenden Snowsound-Technologie und dank der Idee des Paneels, das als Einrichtungsgegenstand dient, innovativ an jedem Ort zum Einsatz kommen kann, an dem die Akustik verbessert werden soll.

E Flap no es tan sólo un panel acústico absorbente, Flap es un objeto de diseño con un notable impacto estético y formal para crear composiciones infinitas con formas cada vez diferentes. Un sistema modular patentado, innovador tanto por la tecnología Snowsound empleada, como por concebir el panel como complemento de decoración que se inserta perfectamente en todas las salas que necesitan una corrección acústica.



XXIV Compasso d'Oro
(Italy)



DesignEuropa Awards
by EUIPO (European Union
Intellectual Property Office)

I I pannelli Flap sono dotati nella parte posteriore di una piastra in acciaio cromato collegata mediante uno snodo sferico articolato ad un braccio in acciaio cromato che può essere fissato direttamente a parete o a soffitto. Lo snodo permette di ruotare il pannello di 360° e di inclinarlo in tutte le direzioni per personalizzare sia gli aspetti estetici del prodotto che quelli di resa acustica.

EN Flap panels feature a rear chrome-plated steel plate connected by an articulated spherical hinge to a chrome-plated steel arm that can be mounted directly to the wall or to a ceiling. The hinge allows the panel to rotate 360° and incline in any direction, in order to personalise the aesthetic aspects and the acoustic performance of the product.

F La partie postérieure des panneaux Flap est dotée d'une plaque en acier chromé reliée, au moyen d'une liaison rotule, à un bras en acier chromé qui peut être fixé directement au mur ou au plafond. La liaison rotule permet de pivoter le panneau sur 360° et de l'incliner dans toutes les directions afin d'en personnaliser tant les aspects esthétiques que le rendement acoustique.

D Die Flap Paneele bestehen aus einer verchromten Stahlplatte auf der Rückseite, die mit einem Arm aus verchromtem Stahl mit Kugelgelenk direkt an der Wand oder der Decke angebracht werden kann. Durch das Gelenk kann das Paneel um 360° gedreht werden und so in alle Richtungen geneigt werden, wodurch das Produkt hinsichtlich der Ästhetik und der Akustikleistung an individuelle Bedürfnisse angepasst werden kann.

E Los paneles Flap llevan en la parte posterior un placa de acero cromado conectada trámite una articulación esférica a un brazo de acero cromado que se puede instalar directamente en la pared o en el techo. Gracias a la articulación esférica el panel puede girar 360° y inclinarse en todas las direcciones para personalizar tanto los aspectos estéticos del producto como también la calibración acústica.

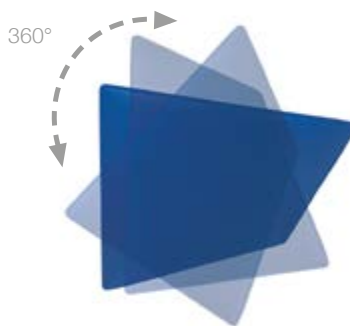
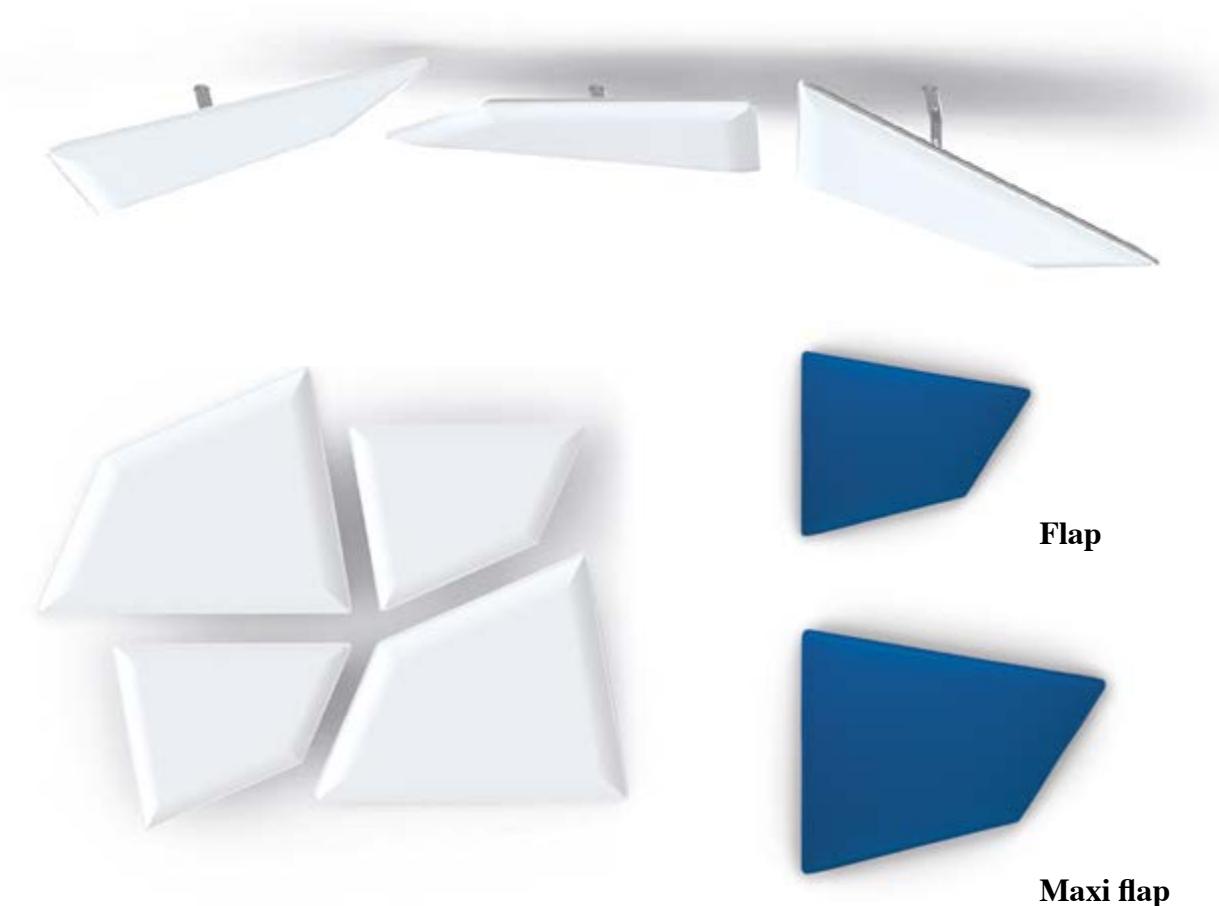

Flap ceiling

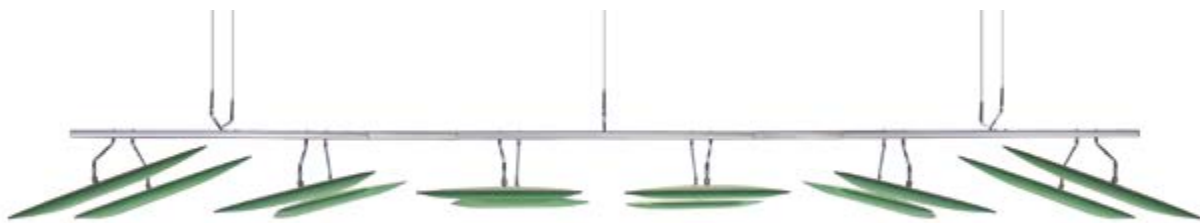
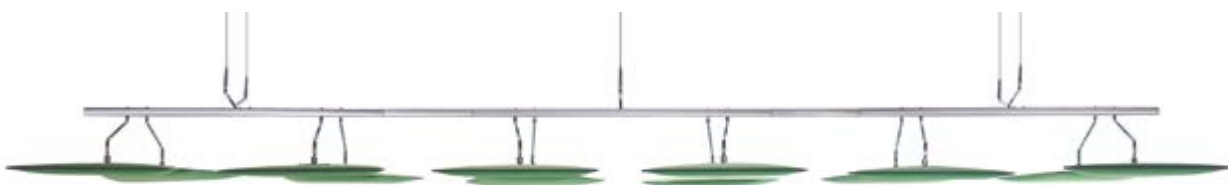
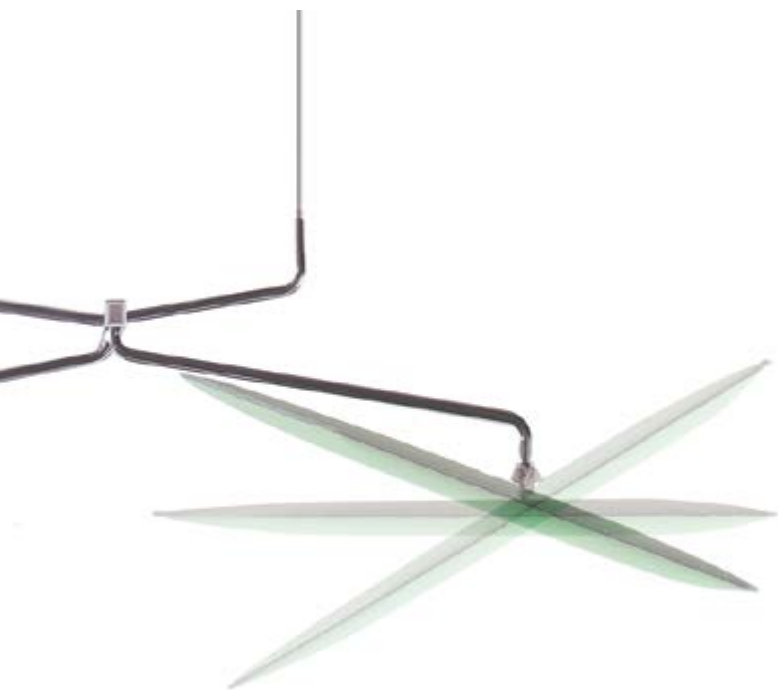



I I telai a soffitto realizzati in acciaio cromato sono dotati di bracci mobili, ai quali vengono applicati i pannelli Flap mediante giunti articolati. I telai sono modulari e possono essere collegati in linea fra di loro. I pannelli possono essere ruotati e inclinati per generare configurazioni planari, concave o convesse in base alle esigenze estetiche ed acustiche. Le configurazioni possono essere facilmente modificate in qualsiasi momento.

EN The ceiling-mounted frames are in chrome-plated steel, fitted with mobile arms, to which Flap panels are anchored with articulated hinges. The frames are modular and can be connected together in a parallel line. The panels can be rotated and inclined to make planar, concave or convex configurations, depending on aesthetic and acoustic needs. The configurations can be easily adjusted at any time.

F Les châssis de montage plafond en acier chromé sont dotés de bras mobiles auxquels les panneaux Flap sont fixés au moyen de liaisons rotule. Les châssis sont modulables et peuvent être reliés entre eux de manière linéaire. Les panneaux pivotants et inclinables permettent de former des agencements planes, concaves ou convexes selon les exigences esthétiques et acoustiques. Les agencements sont aisément modifiables à tout moment.

D Die Rahmen aus verchromtem Stahl an der Decke verfügen über bewegliche Arme, an denen die Flap-Paneele über die Drehgelenke angebracht werden. Die Rahmen bestehen aus Modulen, die in einer Reihe miteinander verbunden werden können. Die Paneele können gedreht und geneigt werden, um je nach gewünschter Ästhetik und Akustik eben, konkav oder konvex ausgerichtet zu werden. Die Einstellungen können einfach und jederzeit verändert werden.

E El bastidor de acero cromado del techo está equipado con brazos móviles, a los que se aplican los paneles Flap mediante articulaciones esféricas. Los bastidores son modulares y se pueden colocar conectándolos en batería. Los paneles se pueden girar e inclinar para crear configuraciones planas, cóncavas o convexas conforme a las necesidades estéticas y acústicas. Las configuraciones se pueden modificar fácilmente en cualquier momento.

Flap lux



I I pannelli fonoassorbenti Flap montati a parete possono essere accessoriati con un sistema di retroilluminazione a LED. Anche il sistema a telaio sospeso Flap Ceiling è accessoriabile con lampade a LED orientabili di 180° per ottenere l'illuminazione desiderata.

F Les panneaux phono-absorbants Flap fixés aux parois peuvent être munis d'un système de rétroéclairage par lampes LED. Le système à châssis suspendu Flap Ceiling peut également être muni de lampes LED orientables à 180° pour obtenir l'éclairage souhaité.

EN The wall-mounted Flap sound-absorbing panels can be decorated with a backlit LED system. The suspended Flap Ceiling frame system can be accessorized with 180° directional LED lighting to achieve the desired illumination.

D Die an der Wand angebrachten schallabsorbierende Flap-Paneele können mit LED-Hintergrundbeleuchtung ausgestattet werden. Auch das von der Decke abgehängte Flap Ceiling-System kann mit bis zu 180° schwenkbaren LED-Leuchten ausgerüstet werden, um die gewünschten Beleuchtungseffekte zu erzielen.

E Los paneles fonoabsorbentes Flap montados en las paredes pueden estar equipados con un sistema de retroiluminación LED. También el sistema con bastidor suspendido Flap Ceiling se puede equipar con focos LED orientables hasta 180° para conseguir la iluminación que se desea.



Flap chain



I Flap chain è un sistema composto da aste verticali ed orizzontali in metallo cromato, innestate l'una nell'altra mediante un incastro che permette la rotazione a 360° delle stesse. Ad ogni asta verticale è fissato un cavo regolabile in altezza per la sospensione a soffitto e un pannello Flap o Maxi Flap, dotato a sua volta di uno snodo che ne consente la rotazione e l'inclinazione. L'unione di aste verticali ed orizzontali consente di creare differenti strutture sospese.

EN Flap chain is a system made up of vertical and horizontal poles in chrome-plated metal, which fit together via a joint that allows 360° degrees rotation. Each vertical pole features a length adjustable cable in order to be suspended from the ceiling and a Flap or Maxi Flap panel equipped with a hinge that allows panel's rotation and inclination. Vertical and horizontal poles connect with each other creating different suspended structures.

F Flap chain est un système composé par des tiges verticales et horizontales en métal chromé, emboîtées l'une dans l'autre par un verrouillage qui permet une rotation de 360°. A chaque tige verticale est fixé un câble à hauteur réglable pour la suspension au plafond et un panneau Flap ou Maxi Flap, muni d'une articulation qui en permet la rotation et l'inclinaison. L'union des tiges, verticales et horizontales permet de créer différentes structures suspendues.

D Flap chain ist ein System, das aus ineinandergesteckten waag- und senkrechten Stangen aus verchromtem Metall besteht, die eine 360°-Drehung ermöglichen. An jeder vertikalen Stange ist ein in der Höhe verstellbares Seil für die Anbringung an der Decke befestigt, sowie ein Flap- oder Maxi-Flap-Paneel, das wiederum über ein Gelenk verfügt, durch das es gedreht und geneigt werden kann. Die Art und Weise wie die senk- und waagrechten Stangen verbunden werden, erlaubt es, verschiedene Hängestrukturen zu bilden.

E Flap chain es un sistema compuesto por barras verticales y horizontales de metal cromado, que se ensamblan mediante un empalme que les permite rotar 360°. Cada barra vertical lleva un cable para ajustar la altura cuando se cuelga del techo y un panel Flap o Maxi Flap, también equipado con una articulación para poderlo rotar o inclinar. Las barras verticales y horizontales se pueden ensamblar creando diferentes estructuras colgantes.



V-Flap



I Con V-Flap si possono realizzare soluzioni fonoassorbenti di grande impatto visivo. Il telaio in acciaio cromato, tenuto in sospensione da sottili cavi metallici, ed i due pannelli fonoassorbenti in posizione inclinata generano l'immagine di due ali che volano nello spazio.

EN V-Flap makes it possible to achieve sound-absorbing solutions with enormous visual impact. The chrome-plated steel frame, held in suspension by metal cables, and the two leaning sound-absorbing panels create the image of two wings that fly through space.

D Mit V-Flap kann man schalldämmende Lösungen mit einer großen optischen Wirkung realisieren. Der Rahmen aus verchromtem Stahl, der durch dünne Metallkabel aufgehängt wird, sowie die beiden schräg angebrachten schalldämmenden Paneele wirken wie zwei Flügel, die sich im Raum bewegen.

F V-Flap permet de réaliser des solutions de phono-absorbance d'un grand impact visuel. Le chassis en acier chromé, suspendu par de minces câbles en métal, et les deux panneaux phono-absorbants placés en position inclinée créent l'image de deux ailes qui volent dans l'espace.

E V-Flap se pueden realizar soluciones fonoabsorbentes de notable impacto visual. El bastidor de acero cromado, que cuelga de delgados cables metálicos y los dos paneles fonoabsorbentes colocados inclinados se perciben como dos alas volando en el espacio.



Flap totem

I Flap Totem è composto da una struttura in acciaio cromato alla quale sono fissati 6 pannelli Flap orientabili. La base della struttura è in acciaio verniciato. Elegante e pratico, unisce la funzione di correzione acustica alla caratteristica di poter essere facilmente spostato e riposizionato.

EN Flap Totem is a chrome-plated steel structure onto which are anchored six adjustable Flap panels. The base is in epoxy powder-coated steel. It is elegant yet practical and combines the feature of acoustic correction with the distinction of being easy to move and repositioned as required.

F Flap Totem se compose d'une structure en acier chromé à laquelle sont fixés 6 panneaux Flap orientables. La base de la structure est en acier peint. Élégant et pratique, il combine la fonction de correction acoustique à sa capacité d'être facilement déplacé et repositionné.

D Flap Totem besteht aus einer verchromten Stahlstruktur, an welcher 6 schwenkbare Flap-Paneele befestigt sind. Der Unterbau der Struktur ist aus lackiertem Stahl. Elegant und praktisch in der Form, vereint das gleich zwei Funktionen: es sorgt für die Schallregulation in Räumen und lässt sich problemlos von einem Ort zum anderen transportieren.

E Flap Totem consta de una estructura de acero cromado a la que se anclaron 6 paneles Flap orientables. La base de la estructura es de acero barnizado. Elegante y práctico, compagina la función de corrección acústica con la característica que se puede trasladar fácilmente y colocar en otra parte.



Baffle

Marc
Sadler



I Baffle è un sistema brevettato che permette di sospendere a soffitto i pannelli fonoassorbenti Snowsound, esaltandone le caratteristiche di leggerezza ed eleganza. La possibilità di regolazione in altezza dei cavi e la varietà di misure e colori disponibili, permettono di ottenere composizioni sia esteticamente che acusticamente personalizzate. Il sistema brevettato di unione del pannello ai cavi è totalmente a scomparsa: un piccolo giunto cilindrico nasconde al suo interno il sistema di fissaggio.

EN Baffle is a patented system designed to hang Snowsound sound-absorbing panels from the ceiling, showcasing its lightness and elegance. The adjustable height of the cables and the array of sizes and colours available make it possible to achieve compositions that can be personalized for aesthetics and sound. The patented joining system of the panel to the cables is completely invisible: a small cylindrical joint hides the anchoring system inside.

F Baffle est un système breveté qui permet de suspendre au plafond les panneaux phono-absorbants Snowsound, en exaltant leurs caractéristiques de légèreté et d'élégance. La possibilité de régler les câbles en hauteur et la variété de dimensions et de coloris disponibles, permettent d'obtenir des compositions personnalisées aussi bien esthétiquement qu'acoustiquement. Le système breveté d'accrochage des panneaux aux câbles est totalement escamotable: un petit joint cylindrique cache en son intérieur le système de fixation.

D Baffle ist ein patentiertes System für die Deckenmontage der schallabsorbierenden Snowsound-Paneele. Auf diese Weise werden die Eigenschaften der Leichtigkeit und der Eleganz in den Vordergrund gestellt. Durch die Möglichkeit die Länge der Stahlseile zu variieren und die Auswahl an zur Verfügung stehenden Maßen und Farben erhält man ästhetisch und akustisch gesehen personalisierte Lösungen. Die patentierte Halterung der Paneele an den Stahlseilen ist völlig unsichtbar: eine kleine zylinderförmige Verbindung verbirgt in ihrem Inneren das Befestigungssystem.

E Baffle es un sistema patentado para colgar del techo los paneles fonoabsorbentes Snowsound, acentuando su elegancia y ligereza características. Gracias a la posibilidad de ajustar la longitud de los cables y el surtido de colores y medidas disponibles, se pueden personalizar estéticamente y acústicamente las configuraciones

El sistema patentado de unión del panel con los cables es totalmente oculto: el sistema de fijación queda escondido dentro de un pequeño empalme cilíndrico.

I Gli agganci Baffle sono posizionabili lungo il bordo superiore del pannello, senza particolari vincoli di interasse tra i cavi, in modo da semplificare l'installazione a soffitto.

EN Baffle anchors can be positioned along the upper edge of the panel, without particular limitations of space between the cables, in order to simplify ceiling installation.

F Les fixations Baffle peuvent être placées le long du bord supérieur du panneau, sans contraintes particulières d'entraxe entre les câbles, de façon à simplifier l'installation au plafond.

D Die Baffle-Halterungen können entlang der oberen Kante des Panels positioniert werden, ohne dass dabei besondere Vorgaben im Hinblick auf den Abstand zwischen den Stahlseilen bestehen. Die Montage an der Decke wird dadurch sehr einfach.

E Las sujeciones Baffle se pueden colocar a lo largo del borde superior del panel, sin limitaciones especiales de distancia entre los cables, para que resulte más sencilla la instalación en el techo.

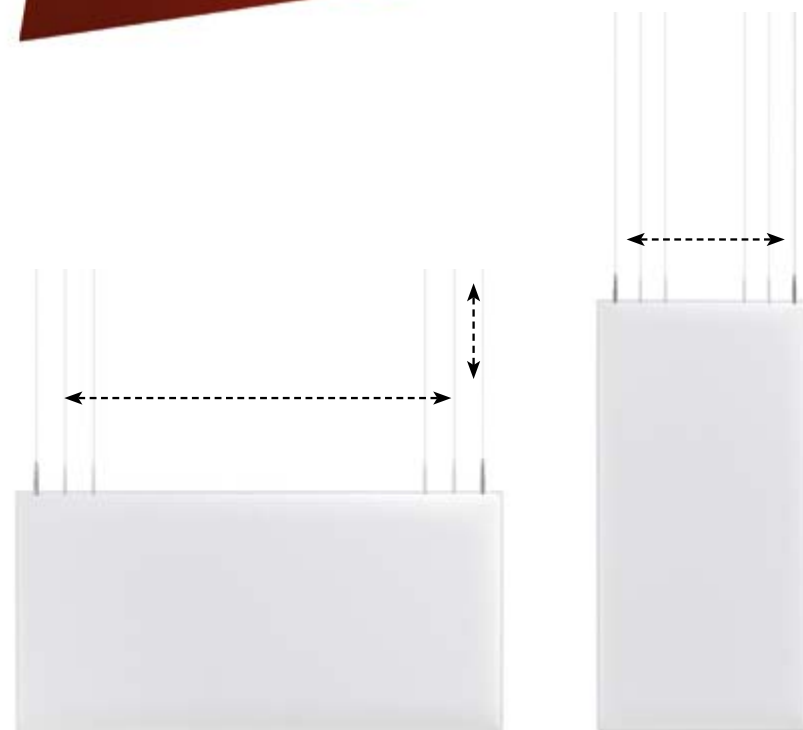
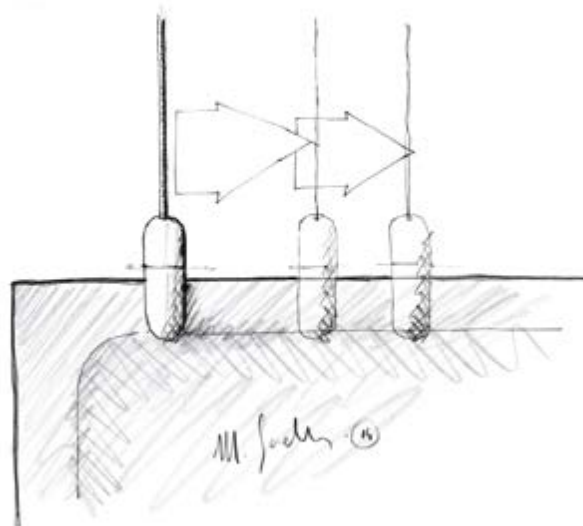
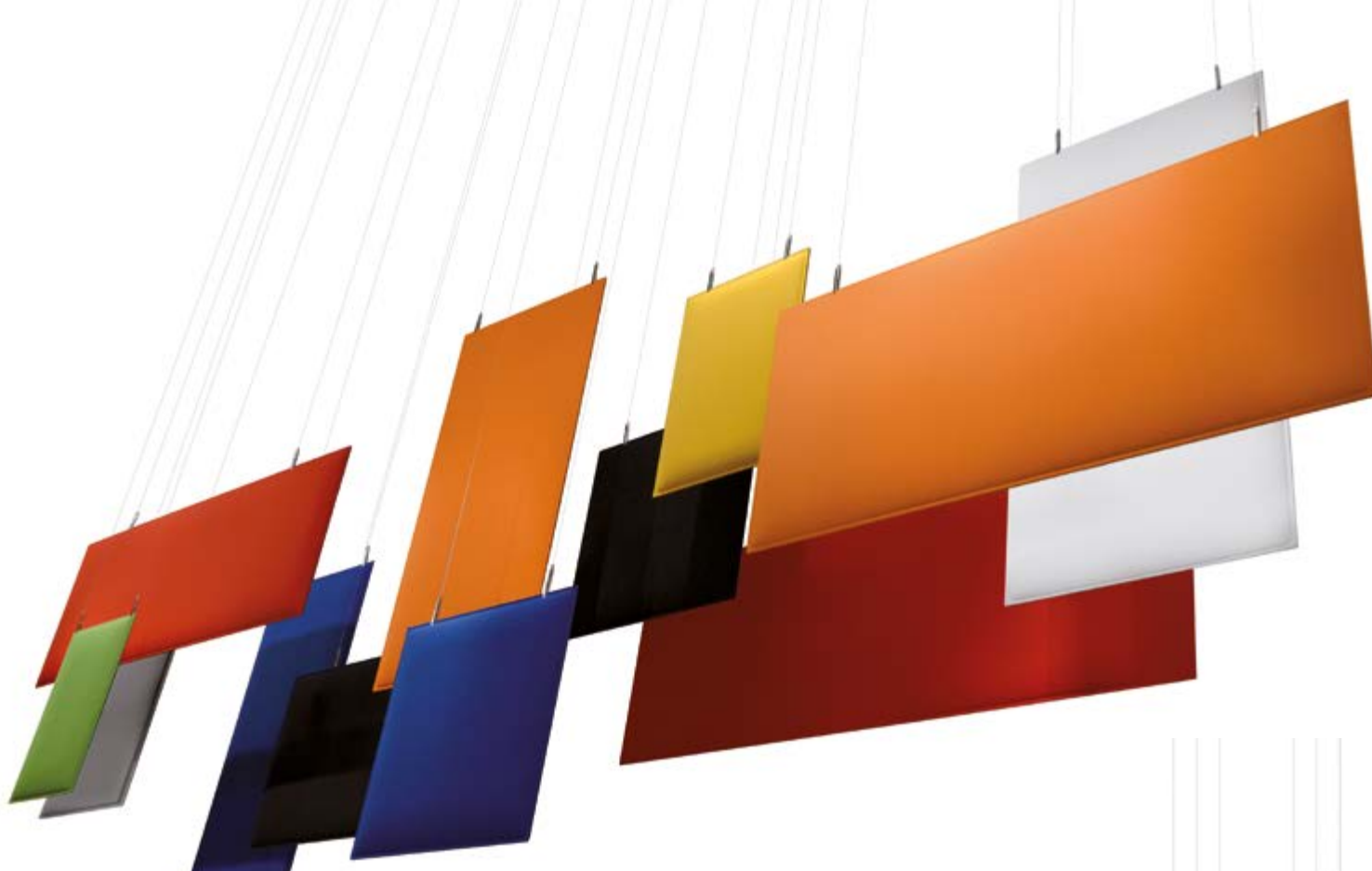

Baffle Oversize

Marc
Sadler



I Baffle Oversize è un sistema brevettato che permette di sospendere a soffitto i pannelli fonoassorbenti Snowsound di grandi dimensioni. Il sistema di unione del pannello ai cavi, nasconde al suo interno il meccanismo di fissaggio al pannello e il sistema di regolazione in altezza dei cavi. Gli agganci sono in metallo pressofuso cromato e sono posizionabili lungo il bordo superiore del pannello in modo da semplificare l'installazione a soffitto.

EN Baffle Oversize is a patented system meant for hanging large Snowsound sound-absorbing panels from the ceiling. The connecting system that joins panel and cables hides inside both the panel fixing mechanism and the regulation system for cables' height. The anchors are in die-cast, chrome-plated metal and can be freely positioned along the whole upper edge of the panel in order to simplify ceiling installation.

F Baffle Oversize est un système breveté qui permet de suspendre au plafond les panneaux phono-absorbants Snowsound de grandes dimensions. Le système de fixation des panneaux aux câbles cache à l'intérieur le mécanisme de fixation au panneau et le système de réglage en hauteur des câbles. Les crochets sont en métal coulé sous pression chromé et peuvent être placés le long du bord supérieur du panneau de manière à simplifier l'installation au plafond.

D Baffle Oversize ist ein patentiertes System, mit dem große schallabsorbierende Snowsound-Paneele an die Decke gehängt werden können. Das System für die Verbindung des Paneels mit den Stahlseilen ist nicht sichtbar, indem sowohl die Befestigung am Paneel als auch die Verstelleinrichtung für die Seillänge versteckt werden. Die Verankerungen bestehen aus verchromtem Metallguss und können am oberen Rand des Paneels befestigt werden, um das Anbringen an der Decke zu erleichtern.

E Baffle Oversize es un sistema patentado para colgar del techo los paneles fonoabsorbentes Snowsound de gran tamaño. En el interior del sistema de unión del panel a los cables, se esconde el mecanismo de fijación al panel y el sistema de ajuste de la altura de los cables. Las sujeciones son de metal fundido cromado y se pueden colocar a lo largo del borde superior del panel para que resulte más sencilla la instalación en el techo.



Tra

Marc
Sadler



I “Due cavi paralleli sono il binario strutturale di una composizione di pannelli di un efficace impianto fonoassorbente, propedeutico a migliorare la qualità del suono negli ambienti. La possibilità di fissare liberamente i pannelli lungo cavi, consente di costruire coreografie molto scenografiche.”

EN “Two parallel cables make up the structural track in a composition of panels that creates an effective sound absorbing system, one element improving the sound quality of the space. The ability to freely locate the panels along the cables makes it possible to construct dramatic backdrops.”

F “Deux câbles parallèles constituent les rails naturels de la structure d’une composition de panneaux comportant une installation d’isolation acoustique des plus efficaces destinée à améliorer la qualité du son dans les locaux. La possibilité de fixer librement les panneaux le long des câbles permet de créer des chorégraphies particulièrement intéressantes.”

D “Zwei parallele Kabel bilden die Gleitstruktur für eine Komposition von Paneelen mit effizientem Schalldämpfungssystem, das dazu dient, die Raumakustik zu verbessern. Durch die flexible Montage der Paneele auf Kabeln können atemberaubende Kompositionen erzeugt werden.”

E “Dos cables paralelos son el carril estructural de la configuración de paneles para una instalación eficaz fonoabsorbente, básica para mejorar la calidad del sonido en el local. La posibilidad de fijar libremente los paneles a lo largo de los cables ofrece la posibilidad de concebir coreografías muy escenográficas.”

Snowsound Technology

Design

Mitesco

Michele
De Lucchi

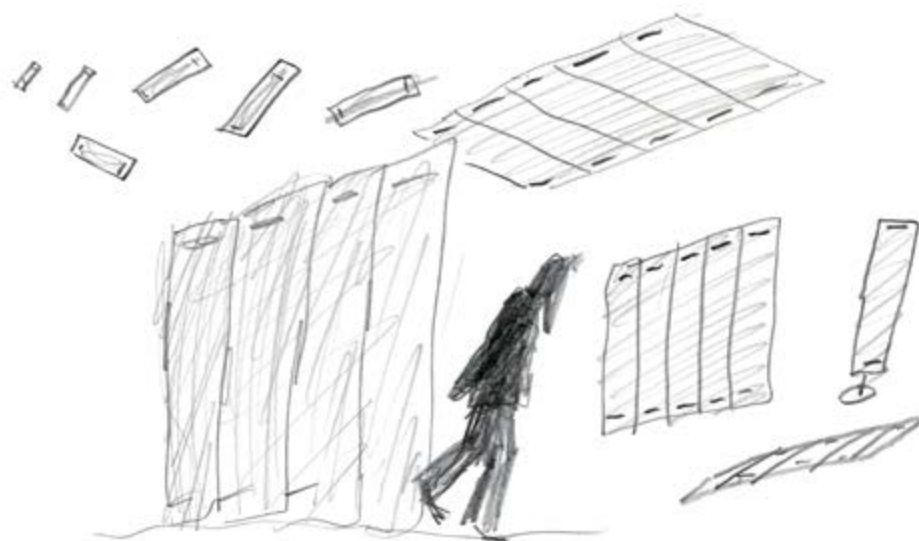
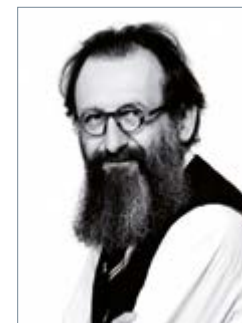

I "Il nostro livello di sofisticazione è sempre più elevato e non trattiamo più l'ambiente in base ai suoi connotati formali e di colore ma in base a elementi più raffinati, cioè elementi sensoriali. La questione dell'acustica è molto complessa e per risolverla c'è bisogno di soluzioni estremamente semplici e non invasive. Il progetto sviluppato con Caimi è un pannello acustico che ha la dote di essere realizzato in un unico materiale, il poliestere, che alle ottime qualità di assorbimento aggiunge il fatto di essere completamente riciclabile, non avendo inclusioni di altri materiali. Il prodotto è leggero, colorato e sufficientemente "basic" da essere utilizzato anche per personalizzare l'ambiente, essendo inseribile appieno nei contesti contemporanei. Può essere appeso e sostenuto da piedistalli: è pratico ed economico."

F "Notre niveau de sophistication est de plus en plus évolué et nous ne traitons pas l'environnement sur la base de ses caractéristiques formelles ou de coloris, mais sur la base d'éléments raffinés, c'est-à-dire des éléments sensoriels. La question de l'acoustique est très complexe et afin de la résoudre il faut des solutions extrêmement simples et non invasives. Le projet développé par Caimi est un panneau acoustique fait avec un seul matériel, le polyester, qui juxtapose aux excellentes qualités d'absorption le fait d'être entièrement recyclable, compte tenu qu'aucun autre matériel n'est prévu. Le produit est léger, coloré et suffisamment de base afin de l'utiliser pour personnaliser toute ambiance, compte tenu qu'il peut être utilisé pour meubler toute ambiance. Il est possible de le fixer et de le faire soutenir par des piétements, il est pratique et économique."

D "Unsere Ansprüche an unsere Umgebung werden immer höher und wir beurteilen sie zunehmend nicht nur hinsichtlich Form und Farbe, sondern basierend auf komplexeren, im Besonderen sensorischen, Kriterien. Das Thema Akustik ist sehr komplex, umso mehr bedarf es einfacher und unkomplizierter Lösungen. Das mit Caimi entwickelte Projekt ist ein akustisches Panel, das nur aus einem einzigen Material, Polyester, besteht, und sich daher neben seiner hervorragenden akustischen Eigenschaften dadurch auszeichnet, dass es komplett recyclebar ist. Das Produkt ist leicht, farbenfroh und unkompliziert genug um sogar zur individuellen Gestaltung der Umgebung verwendet zu werden, da es sich völlig in einen zeitgemäßen Kontext einfügt. Es kann aufgehängt und auf Standfüßen montiert werden, ist praktisch und preisgünstig."

E "Nuestro nivel de sofisticación es siempre más elevado y ya no tratamos más el ambiente en base a sus connotaciones formales y de color, sino también en base a elementos más refinados, es decir, elementos sensoriales. La cuestión de la acústica es muy compleja y para resolverla se necesitan soluciones muy simples y no invasivas. El proyecto desarrollado con Caimi es un panel acústico que tiene la dote de estar realizado con un único material, el poliéster, que a las óptimas características de absorción acústica añade el hecho de ser completamente reciclable, al no incluir otros materiales. El producto es liviano, de color y suficientemente "basic" para ser utilizado también para personalizar el ambiente, encajando perfectamente en los contextos contemporáneos. Se puede colgar o sujetares a montantes verticales. Es práctico y económico."

EN "Our level of sophistication strives to be ever higher, and we no longer treat our surroundings based on their form and colour, but on more refined elements, namely sensory elements. The issue of acoustics is very complex, extremely simple and non-invasive solutions are needed to resolve it. The project developed with Caimi is an acoustic panel that is made with one single material, polyester, which in addition to its excellent absorbent qualities is completely recyclable, as it does not contain any other materials. Mitesco is light, colourful and sufficiently basic to be used even to personalise the surrounding area, as it can be fully inserted in a contemporary context. It can be hung and supported on a stand: it is practical and inexpensive."



Mitesco

I Il pannello fonoassorbente Mitesco è dotato di due supporti che ne permettono il fissaggio alle pareti o a staffe in acciaio che mantengono il pannello staccato dalla parete per ottimizzarne le prestazioni acustiche. Il pannello fonoassorbente Mitesco può anche essere agganciato a chiodi/viti fissati nelle pareti mediante un gancio.

EN The sound-absorbing Mitesco panels has two supports that allow it to be anchored to walls or to steel supports which keep the panel detached from the wall so as to optimise the acoustic performance. Mitesco sound-absorbing panels can be held in place by nails or screws anchored to walls with a hook.

F Le panneau phono-absorbant Mitesco est muni de deux supports qui permettent de le fixer aux parois ou à des supports en acier qui maintiennent le panneau détaché de la paroi pour optimiser les prestations acoustiques. Le panneau phono-absorbant Mitesco peut également être fixé à des clous ou à des vis fixés dans les murs, grâce à un crochet.

D Das schallabsorbierende Paneel Mitesco weist zwei Halterungen auf, dank derer man es direkt an der Wand oder an Abstandhaltern aus Stahl befestigen kann. Das Paneel wird somit von der Wand entfernt montiert und die akustische Leistung optimiert. Das schallabsorbierende Paneel Mitesco kann auch mit Hilfe eines Hakens durch Nägel oder Schrauben an der Wand befestigt werden.

E El panel fonoabsorbente Mitesco lleva dos soportes para fijación mural o a otros soportes de acero para que el panel quede alejado de la pared y se logre un rendimiento acústico óptimo. El panel fonoabsorbente Mitesco también se puede anclar, mediante un gancho, a clavos/tornillos clavados en las paredes.

Easy removable



Fixed

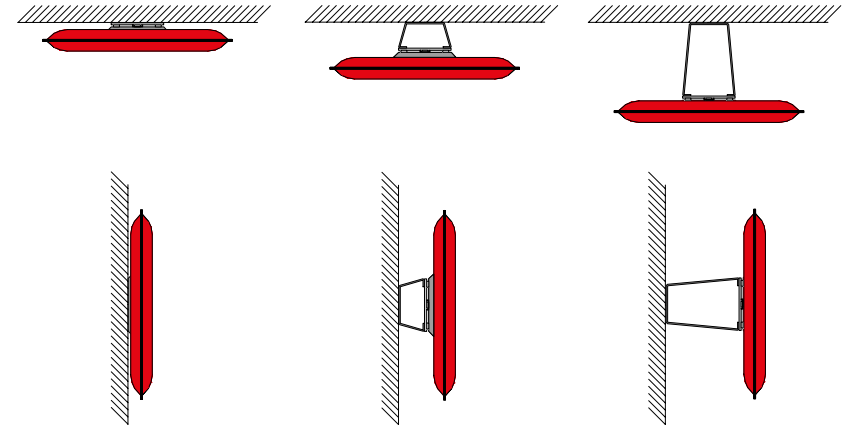

Magnetic



I Gli attacchi magnetici permettono, anche grazie alla leggerezza del pannello ed all'assenza di telai rigidi e spigolosi in alluminio o PVC (normalmente utilizzati in similari dispositivi fonoassorbenti), di applicare e di rimuovere facilmente i pannelli.

EN Magnetic connections make it easy to quickly apply or remove the panels. This is possible thanks to the lightness of the panel and the absence of rigid, sharp-edged aluminum/PVC frames (normally adopted in similar acoustic devices).

D Dank der Leichtigkeit des Paneels sowie dem Verzicht auf starre und kantige Rahmen aus Aluminium oder PVC (die normalerweise bei ähnlichen akustischen Elementen verwendet werden) ermöglichen die Magnetbefestigungen es, die Paneele einfach anzubringen und abzunehmen.

F Les connexions magnétiques permettent, grâce à la légèreté du panneau et à l'absence de cadres rigides ou coupants en aluminium ou en PVC (généralement utilisés pour des dispositifs similaires phono-absorbants), de fixer et enlever aisément les panneaux.

E Los enganches magnéticos permiten, también gracias a la liviandad del panel y al no tener bastidores rígidos y angulosos de aluminio o PVC (normalmente utilizados en dispositivos fonoabsorbentes similares), aplicar y remover fácilmente los paneles.



Mitesco cables

I I pannelli Mitesco possono essere sospesi su cavi in acciaio con supporti per fissaggio a parete o a soffitto/pavimento.

EN Mitesco panels can be hung from steel cables and come with dedicated supports for wall or ceiling/floor fixing.

F Les panneaux Mitesco peuvent être suspendus sur des câbles en acier avec supports pour la fixation au mur ou au plafond/sol.

D Mitesco-Paneele können an Stahlkabeln befestigt werden, die mit Halterungen an Wand, Decke oder Boden angebracht werden.

E Los paneles Mitesco se pueden colgar de los cables de acero con soportes para la fijación mural o en el techo/al suelo.





Mitesco divider



I I divisori possono essere realizzati con pannelli posti su un solo lato o su due lati contrapposti, ottenendo così soluzioni fonoassorbenti esteticamente identiche su ambo i lati. Scegliendo nella gamma di colori disponibili, i pannelli Mitesco si possono combinare tra loro liberamente per ottenere mix cromatici interessanti e personalizzati.

F Les cloisons peuvent être réalisés avec des panneaux sur un des côtés ou sur les côtés opposés, en profitant ainsi de solutions phono-absorbantes esthétiquement identiques de deux côtés. En choisissant dans la gamme des coloris disponibles, les panneaux Mitesco se peuvent juxtaposer librement afin d'obtenir des mix chromatiques intéressants et personnalisés.

EN The dividers can be realised with panels placed on one side only or on two opposing sides, thus obtaining sound absorbing solutions aesthetically identical on both sides. Choosing from a range of available colours, the Mitesco panels can be freely combined with each other to obtain interesting and customised colour mixes.

D Die Paneele können als Raumteiler eingesetzt werden. Auf einer oder auf zwei gegenüberliegenden Seiten aufgestellt, werden damit ästhetisch ansprechende und akustisch wirksame Lösungen erzielt. Die Farben der Mitesco Paneele können frei untereinander kombiniert werden. Dadurch kann eine optisch ansprechende Farbgebung und Raumgestaltung erreicht werden.

E Los divisores pueden ser realizados con paneles colocados sobre un solo lado o sobre dos lados contrapuestos, logrando así soluciones fono-absorbentes estéticamente idénticas. Eligiendo entre la gama de los colores disponibles, los paneles Mitesco se pueden combinar libremente entre ellos para lograr mezclas cromáticas interesantes y personalizadas.

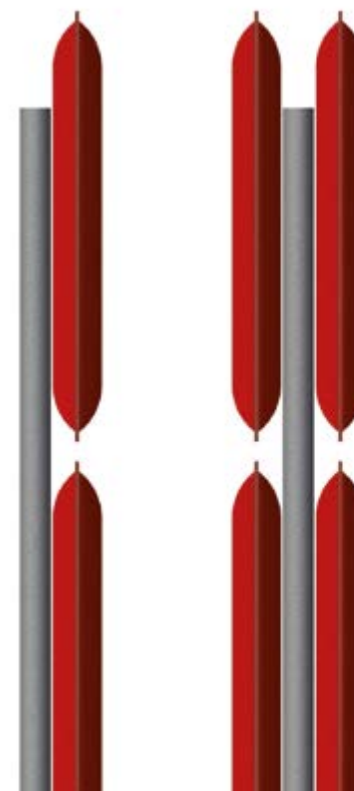

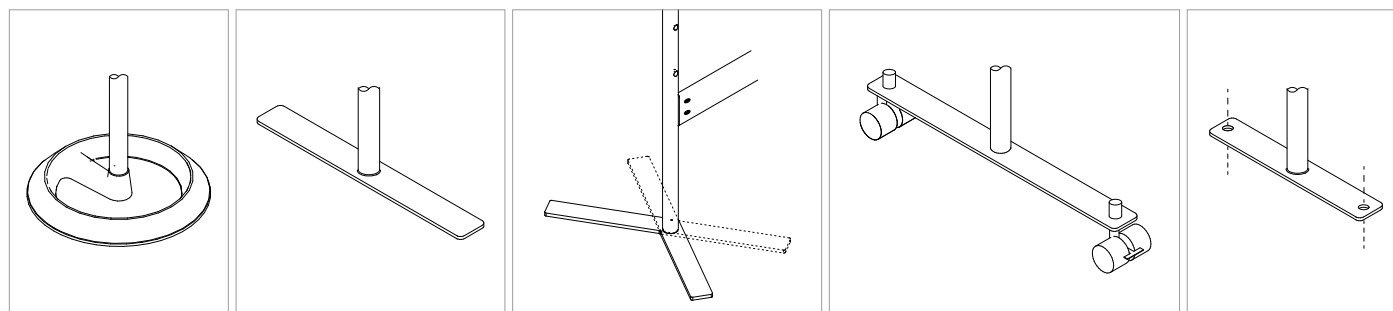

Mitesco totem



I Il gancio in alluminio lucido è un accessorio che permette di integrare nei totem fonoassorbenti Mitesco la funzione di appendiabiti in modo discreto ed elegante.

EN Mitesco sound-absorbing totems are incorporated with a glossy aluminum hook accessory to transform them into a discreet and elegant coat rack.

F Le crochet en aluminium poli est un accessoire qui permet d'intégrer dans les totems phono-absorbants Mitesco la fonction de portemanteau de manière discrète et élégante.

D Bei diesem Haken aus glänzendem Aluminium handelt es sich um ein Zubehör mit welchem man, auf diskrete und elegante Weise, das schallabsorbierende Totem Mitesco mit der Funktion eines Garderobenständers kombinieren kann.

E El gancho de aluminio brillante es un accesorio que complementa, de forma discreta y elegante, el totem fonoabsorbente Mitesco al emplearse como perchero.



Mitesco desk

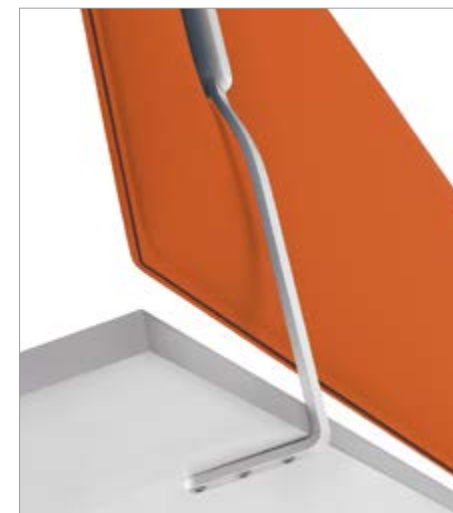

I I pannelli Mitesco sono un'ottima soluzione per suddividere tra loro i piani di lavoro, creando una barriera visiva ed ottimizzando il comfort acustico della singola postazione.

EN Mitesco panels are an excellent solution for subdividing worktops into sections, creating a visual barrier and optimising the acoustic comfort of the individual positions.

F Les panneaux Mitesco représentent la solution la meilleure pour diviser les dessus des bureaux, en créant une barrière visuelle et en optimisant le confort acoustique de chaque poste de travail.

D Die Mitesco Paneele sind eine hervorragende Lösung um Arbeitsbereiche zu unterteilen. Einerseits wird eine Sichtbarriere geschaffen andererseits wird der akustische Komfort der einzelnen Arbeitsplätze wesentlich erhöht.

E Los paneles Mitesco son una excelente solución para dividir entre ellos los planos de trabajo, creando una barrera visual y optimizando el confort acústico del puesto individual.



Mitesco desk

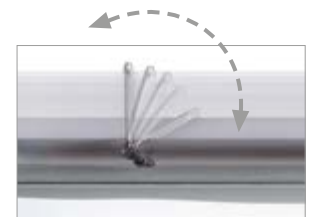
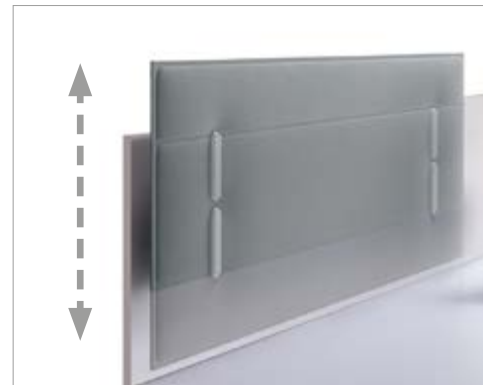

I Grazie a speciali staffe in acciaio verniciato i pannelli Mitesco possono essere appoggiati al piano, in questo modo è possibile cambiare rapidamente la configurazione del piano di lavoro.

EN Thanks to the special powder-coated steel brackets, Mitesco panels can be positioned on the desk quickly changing the layout of the work area.

D Dank der speziellen Halterungen aus beschichtetem Stahl können die Mitesco Paneele auf Oberflächen positioniert werden; dadurch wird die Möglichkeit gegeben, die Konfiguration der Arbeitsfläche zu ändern.

F A travers des étriers spéciaux en acier peint, il est possible d'appuyer les panneaux Mitesco sur le dessus de façon qu'il soit possible de changer rapidement de configuration au niveau du plan de travail.

E Gracias a los soportes especiales de acero recubierto, los paneles Mitesco pueden ser apoyados en el plano; de esa manera es posible cambiar rápidamente la configuración del plano de trabajo.



Corner

Marc
Sadler



I Il sistema Corner, che utilizza pannelli realizzati con la tecnologia Snowsound, è un'ottima soluzione per suddividere i piani di lavoro creando una barriera visiva ed ottimizzando il comfort acustico. Le ridotte dimensioni, associate ad una buona robustezza, sono il punto di forza degli attacchi Corner che permettono di applicare i pannelli Snowsound a scrivania mediante morsetti o direttamente al piano tramite viti.

EN Corner system, which uses Snowsound technology panels, is an ideal way to divide up work surfaces by creating a visual barrier while also optimizing acoustic comfort. A compact size, together with a robust construction, are the strengths of the mounting hardware that makes it possible to apply Snowsound panels to the desk using clamps or directly to the desk with screws.

F Le système Corner utilise les panneaux réalisés avec la technologie Snowsound et offre une excellente solution pour répartir les plans de travail, en créant une barrière visuelle, et optimiser le confort acoustique. Les dimensions réduites associées à une bonne solidité sont le point fort des fixations Corner qui permettent d'appliquer les panneaux Snowsound au bureau à l'aide d'étaux ou directement au plan par des vis.

D Das System Corner, das mit Snowsound-Technologie hergestellte Paneele verwendet, bietet sich als eine ausgezeichnete Lösung um Arbeitsflächen zu trennen. Es können dabei visuelle Barrieren geschaffen und der akustische Komfort wesentlich verbessert werden. Kleine Maße, aber dennoch stabil - das sind die beiden Stärken, die die Befestigungsglieder von Corner auszeichnen. Sie gewährleisten die Befestigung der Snowsound-Paneele mittels Klemmen am Schreibtisch oder anhand von Schrauben direkt an der Schreibtischfläche.

E El sistema Corner, que emplea paneles realizados con la tecnología Snowsound, es una solución excelente para dividir las superficies de trabajo creando una barrera visual y mejorando el confort acústico. Las fijaciones Corner, pequeñas pero muy resistentes, ofrecen a los paneles Snowsound la gran ventaja de poderse sujetar al escritorio mediante mordazas o directamente a la superficie mediante tornillos.

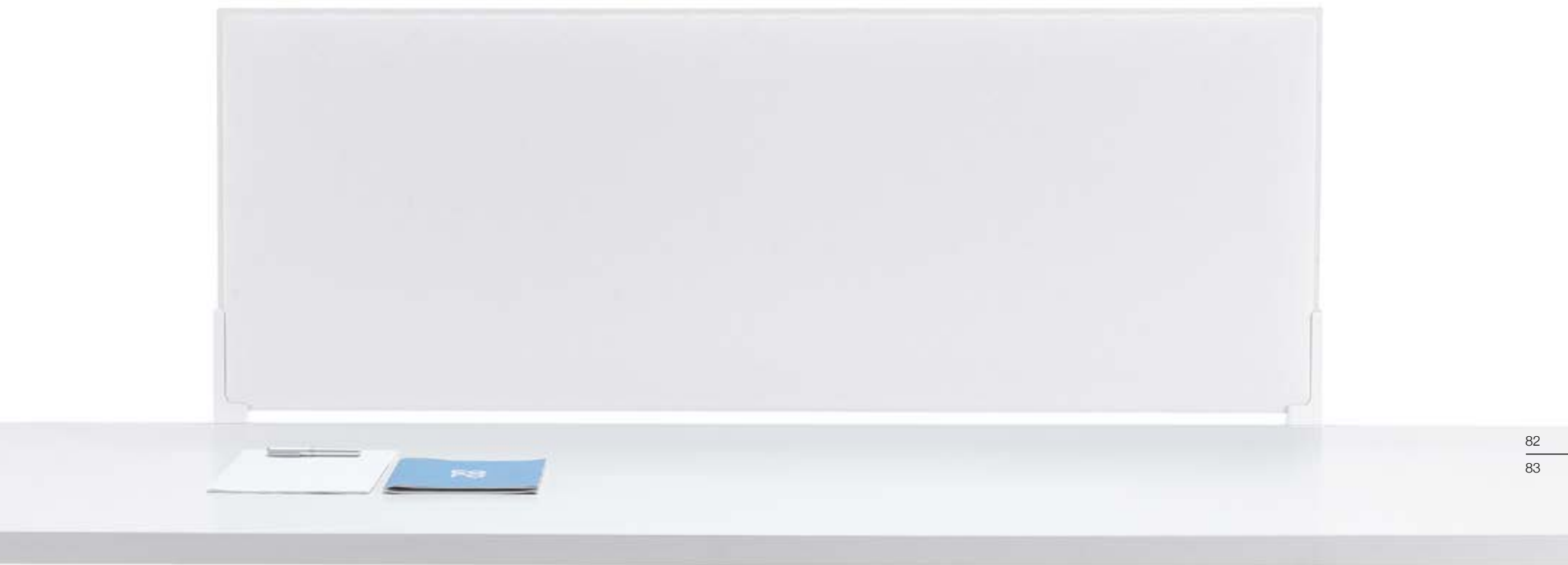

Pli desk

Marc
Sadler



I I pannelli fonoassorbenti Pli possono essere utilizzati anche come divisori da appoggio a scrivania, garantendo comfort acustico, privacy e grande libertà di configurazione grazie alle cinghie elastiche che consentono l'unione dei pannelli con varie angolazioni ed unioni a "T", ad "L" o ad "X".

EN Pli sound-absorbing panels can be also used as desk top partitions, thereby ensuring acoustic comfort, privacy and ultimate freedom of configuration thanks to the elastic straps that hold the panels together to create linear, "T", "L" or "X" formations.

F Les panneaux phono-absorbants Pli peuvent également être utilisés comme cloisons appuyés au bureau et garantir confort acoustique, discrétion et une grande liberté de configuration grâce aux courroies élastiques qui permettent d'unir les panneaux selon différents angles et assemblages en "T", en "L" ou en "X".

D Die schallabsorbierenden Paneele Pli können als Paravent auf Schreibtischen verwendet werden, wodurch akustischer Komfort, Ungestörtheit und absolute Gestaltungsfreiheit gewährleistet werden. Die elastischen Riemen halten die Paneele mit unterschiedlichen Neigungswinkeln sowie "T"-, "L"- oder "X"-förmig zusammen.

E Los paneles fonoabsorbentes Pli se pueden usar también como divisorio para el escritorio, garantizando confort acústico, privacidad y mucha flexibilidad de configuración gracias a las correas elásticas que enlazan los paneles con diferentes ángulos y uniones en "T", en "L" o en "X".

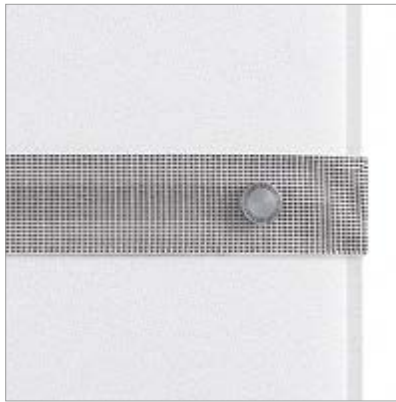

Snowsound Technology

Snowfront

Design

Caimi
Lab

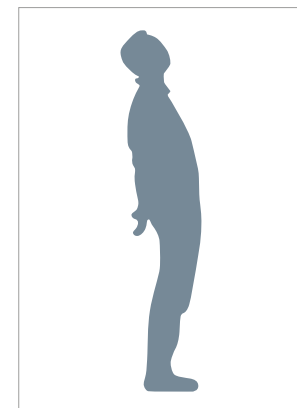

I Il sistema Snowfront, che utilizza pannelli realizzati con la tecnologia Snowsound, è un'ottima soluzione per suddividere i piani di lavoro, creando una barriera visiva ed ottimizzando il comfort acustico.

EN Snowfront system, which uses panels made with Snowsound technology, is an ideal way to divide up work surfaces by creating a visual barrier while also optimising acoustic comfort.

F Le système Snowfront qui utilise les panneaux réalisés avec la technologie Snowsound est une solution excellente pour répartir les plans de travail. Il crée une barrière visuelle et optimise le confort acoustique.

D Das System Snowfront, das mit Snowsound-Technologie hergestellte Paneele verwendet, bietet sich als eine ausgezeichnete Lösung um Arbeitsflächen zu trennen. Es können dabei visuelle Barrieren geschaffen und der akustische Komfort wesentlich verbessert werden.

E El sistema Snowfront, que emplea paneles realizados con la tecnología Snowsound, es una solución excelente para dividir las superficies de trabajo, creando una barrera visual y mejorando el confort acústico.

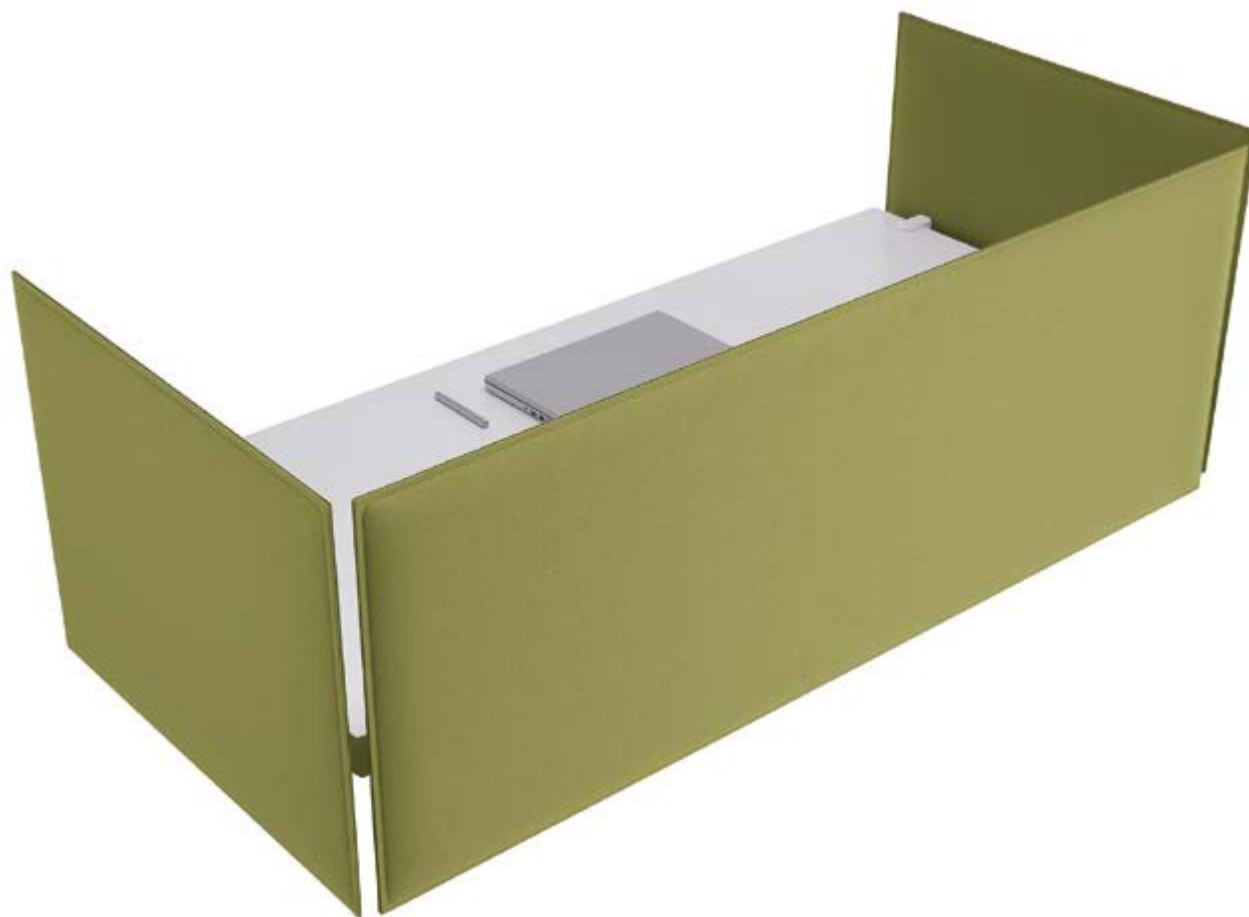
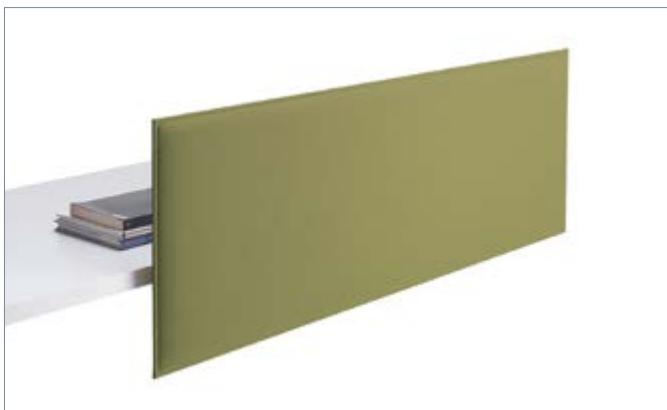

I Snowfront permette il posizionamento dei pannelli al piano della scrivania tramite morsetti in metallo all'altezza desiderata.

EN Snowfront allows the panels to be positioned on the work surface using metal clamps at the desired height.

F Snowfront permet de poser les panneaux sur le plan du bureau à l'aide d'étaux métalliques à la hauteur désirée.

D Anhand von Klemmen können die Snowfront-Paneele direkt an der Schreibtischfläche auf gewünschter Höhe angebracht werden.

E Con Snowfront se pueden sujetar los paneles a la superficie del escritorio tramite mordazas metálicas a la altura deseada.

Snowsound Technology

Oversize desk

Design

**Caimi
Lab**

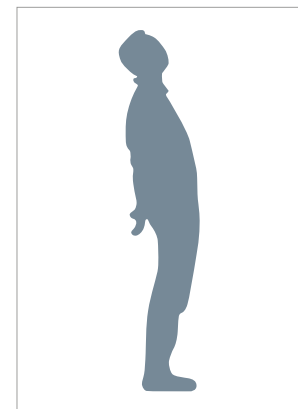

I I pannelli Oversize fissati a scrivania garantiscono una maggiore privacy del posto di lavoro, consentendo anche una separazione degli spazi, nel rispetto di un buon comfort acustico.

EN Oversize panels fixed to desks ensure more privacy of the workplace, while also allowing a separation of spaces, in accordance with a good acoustic comfort.

F Les panneaux Oversize fixés au bureau garantissent plus de confidentialité au poste de travail et offrent la possibilité de répartir l'espace, respectant un bon niveau de confort acoustique.

D Die an den Schreibtisch fixierbaren Oversize-Paneele bieten die Möglichkeit Arbeitsbereiche voneinander zu trennen und somit ein ruhigeres Arbeitsumfeld zu schaffen, ohne dabei den akustischen Komfort zu beeinträchtigen.

E Los paneles Oversize acoplados a escritorios garantizan una mayor privacidad del lugar de trabajo, permitiendo también una separación de los espacios, respetando un buen confort acústico.

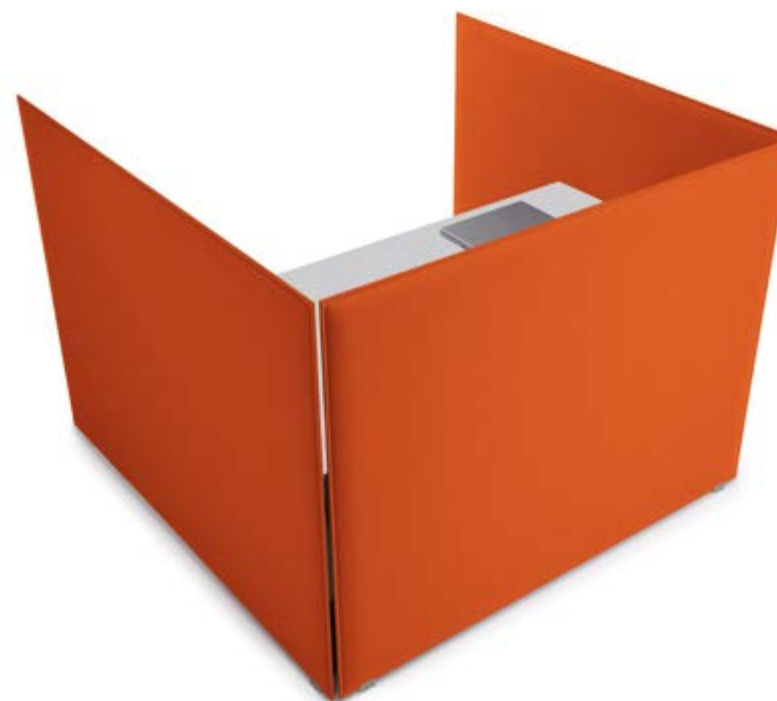

Snowsound Technology

Design

Design Collection

Caimi
Lab





I Sistema di accessori per scrivania che consente di organizzare al meglio il piano di lavoro con elementi contenitori in acciaio e pannelli divisorii fonoassorbenti Snowsound liberamente posizionabili e rapidamente riconfigurabili dall'utente stesso. Il modulo base del sistema è il profilo a U in acciaio sul quale vengono inseriti i pannelli divisorii e gli accessori in acciaio.

EN A selection of desk accessories that allows a functional organization of the workspace. It includes steel containers and Snowsound sound-absorbing panels as dividers that can be easily positioned and quickly reconfigured. The base module is a U-shaped steel profile that accommodates both dividing panels and steel accessories.

F Un système d'accessoires pour bureau qui permet d'organiser au mieux la surface de travail avec des bacs en acier et des cloisons phono-absorbants Snowsound qui peuvent être positionnés librement et configurés rapidement par l'utilisateur. Le module de base du système est le profil en U en acier sur lequel sont insérés les cloisons et les accessoires en acier.

D Accessoires für den Schreibtisch, die die Organisation der Arbeitsfläche erleichtern. Das System besteht aus Behältern aus pulverbeschichtetem Stahlblech und schallabsorbierenden Snowsound-Paneelen als Trennwände, die vom Nutzer nach Belieben verschoben und verändert werden können. Der Grundbaustein ist ein U-Profil aus Stahl, auf dem Panel-Trennelemente und Stahl-Accessoires angebracht werden.

E Sistema de accesorios para el despacho para organizar mejor la superficie de trabajo del escritorio con elementos contenedores de acero y paneles divisorios de absorción acústica Snowsound que el usuario puede colocar y desplazar libre y rápidamente. El módulo básico del sistema es el perfil en U de acero en el que se insertan los paneles divisorios y los accesorios de acero.

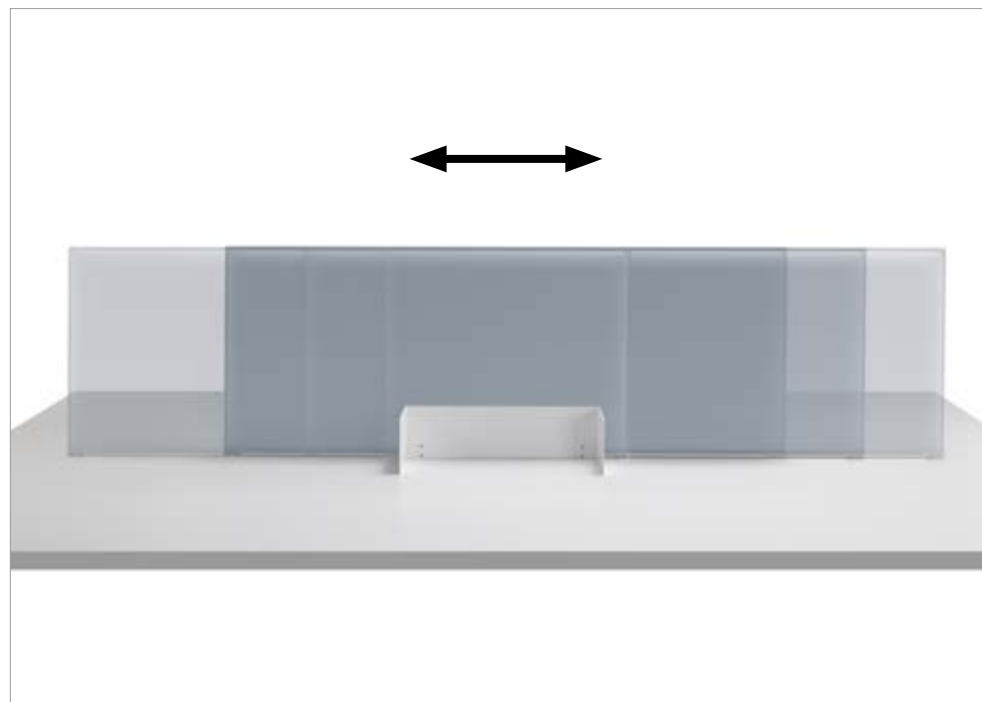

Design Collection



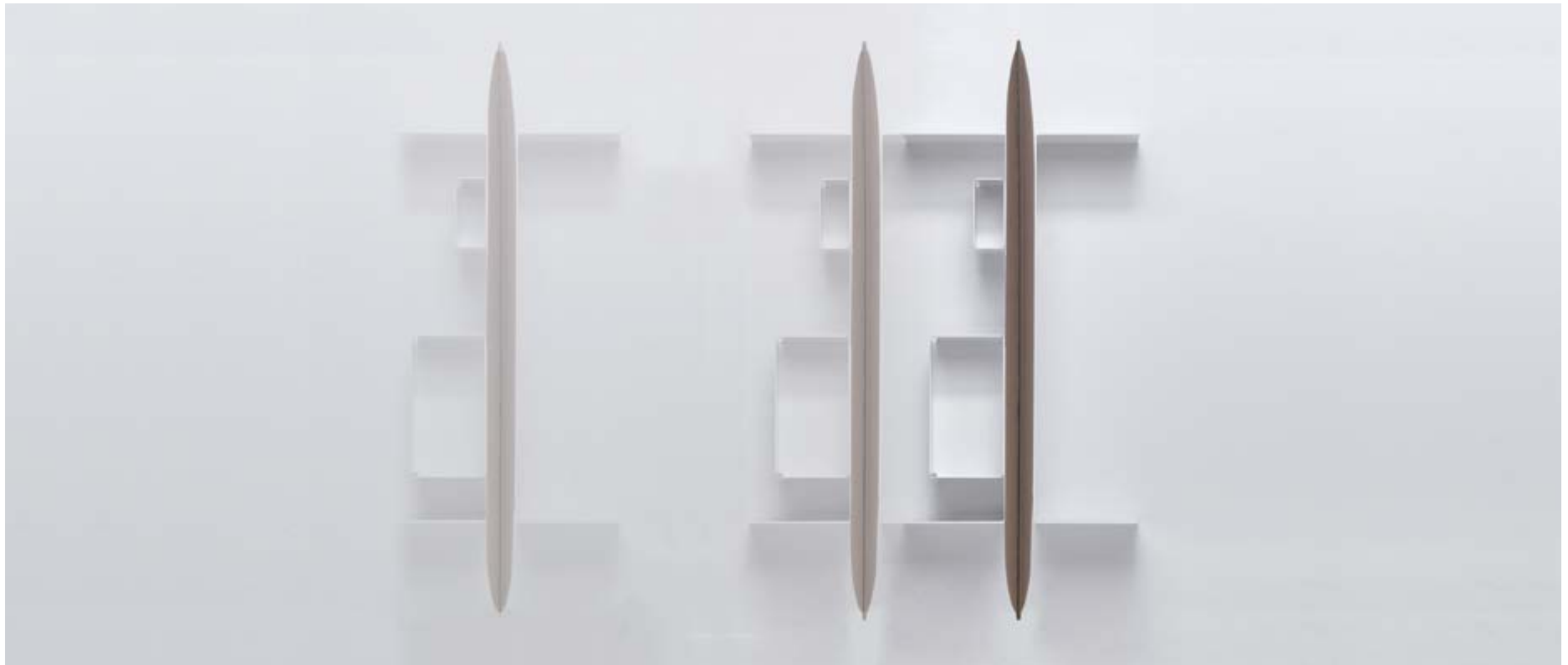

Design Collection



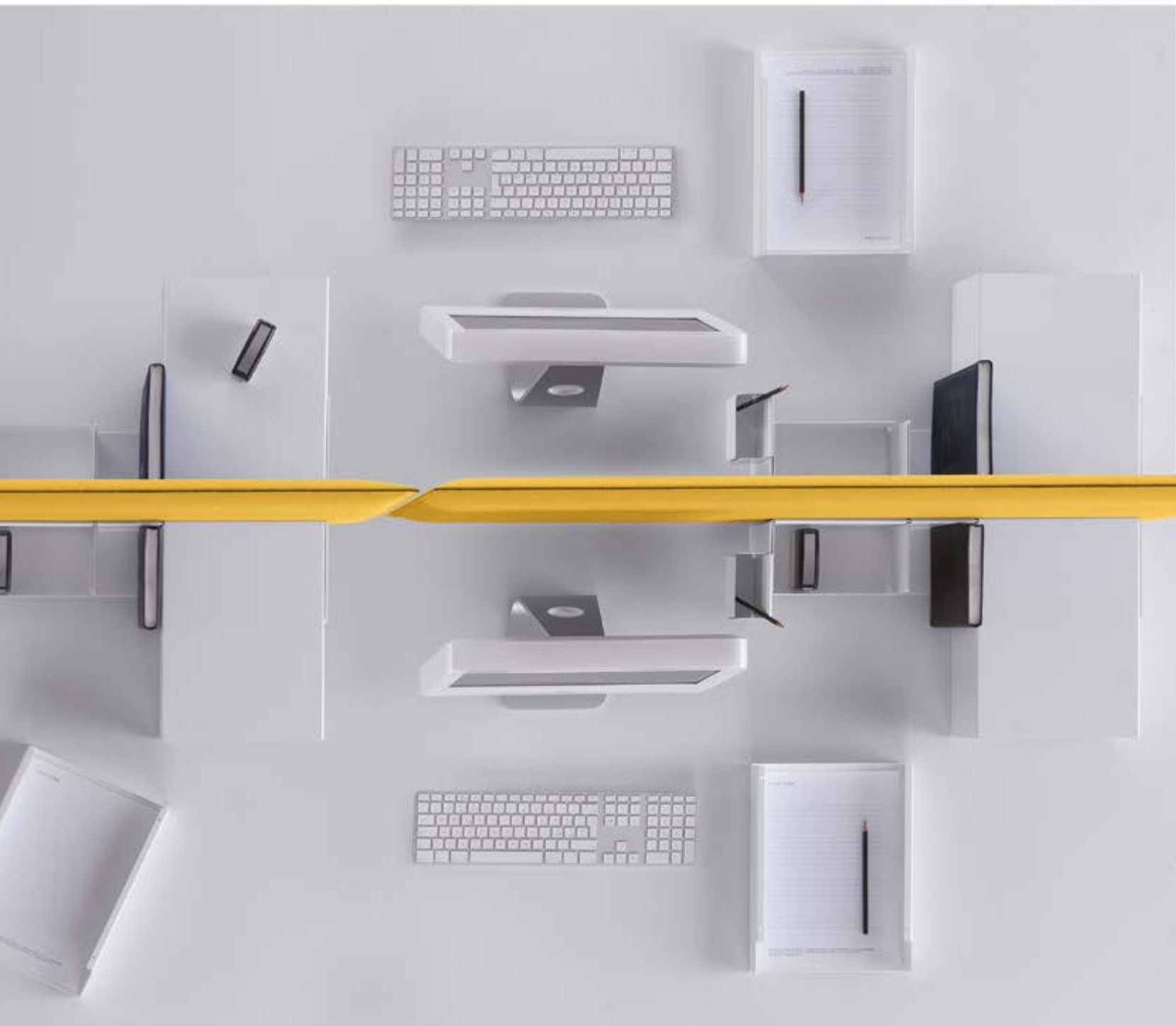

Snowsound Art

Gillo
Dorfles

PER UN GIGANTISMO DEL DISEGNO

Enormous design

UNTITLED, 1937-2017

Sound-absorbing Snowsound panel,
wall / ceiling, 119 x 159 cm



I Snowsound Art è un progetto di Caimi Brevetti che ha come obiettivo un viaggio alla scoperta di nuove strade per far dialogare ARTE e DESIGN. Un modo di vedere l'arte, non solo come una creazione unica, non ripetibile, ma come una "bellezza" riproducibile su oggetti seriali. L'arte non solo da contemplare, l'arte da fruire. Il viaggio inizia con una serie di pannelli fonoassorbenti Snowsound che diventano "tele" sulle quali sono riprodotti una serie di disegni di Gillo Dorfles. Gillo Dorfles, nato a Trieste nel 1910, è pittore, critico d'arte, teorico, storico ed è ritenuto uno dei maggiori studiosi d'arte al mondo.

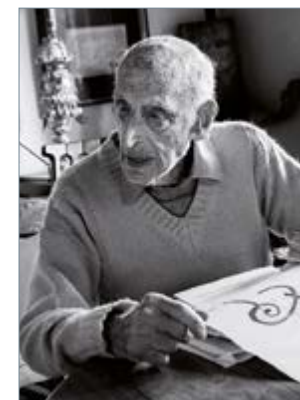

EN Snowsound Art is a Caimi Brevetti project that aims to be a journey of discovery, looking for new ways to bring ART and DESIGN together. A way of interpreting art not just as a unique creation that can't be repeated, but as a form of beauty that can be reproduced on serial objects. Art isn't just to be contemplated. It is to be enjoyed as well. The journey begins with a line of Snowsound sound-absorbing panels that become "canvases", reproducing a series of designs by Gillo Dorfles. Gillo Dorfles, born in Trieste in 1910, is a painter, art critic, philosopher, historian, and is considered one of the most important art scholars in the world.

F Snowsound Art est un projet de Caimi Brevetti proposant un voyage à la découverte de nouvelles voies pour établir un dialogue entre l'ART et le DESIGN. Une manière de voir l'art non seulement comme une création unique, non répétable, mais comme une "beauté" reproductible sur des objets en série. L'art non seulement destiné à être contemplé, mais à être utilisé. Le voyage commence avec une série de panneaux phono-absorbants Snowsound qui se transforment en "toiles" sur lesquelles sont reproduits une série de dessins de Gillo Dorfles. Gillo Dorfles, né à Trieste en 1910, est un peintre, critique d'art, théoricien et historien considéré comme un des plus importants experts mondiaux de l'art.



UNTITLED, 1937-2017

Sound-absorbing Snowsound panel,
wall / ceiling, 119 x 119 cm

D Snowsound Art ist ein Projekt von Caimi Brevetti, dessen Ziel eine Entdeckungsreise ist, auf der neue Wege gesucht werden, um KUNST und DESIGN miteinander in Dialog treten zu lassen. Dabei wird Kunst nicht als einmalige, unwiederholbare Schöpfung betrachtet, sondern als "Schönheit", die auf einer Reihe von Produkten reproduzierbar wird. Eine Kunst, die nicht nur bestaunt werden, sondern auch genutzt werden kann.

Die Reise beginnt mit einer Reihe von schallabsorbierenden Snowsound-Paneelen, die zu "Leinwänden" werden, auf denen Bilder von Gillo Dorfles abgebildet sind.

Der 1910 in Triest geborene Gillo Dorfles ist Maler, Kunstkritiker, Philosoph, Historiker und wird als einer der wichtigsten Kunstwissenschaftler weltweit angesehen.

E Snowsound Art es un proyecto de Caimi Brevetti: un viaje para explorar itinerarios nuevos que compaginen ARTE y DISEÑO .

Una forma de concebir el arte, que no es tan sólo una creación única, irrepetible, sino también una "belleza" duplicable en objetos en serie. Un arte que se admira pero también un arte que se disfruta.

El viaje inicia con una serie de paneles fonoabsorbentes Snowsound, son como "lienzos" en los que se duplicaron una serie de dibujos de Gillo Dorfles.

Gillo Dorfles, nació en Trieste en 1910, es pintor, crítico de arte, teórico, historiador y se le considera uno de los principales conocedores de arte en el mundo.

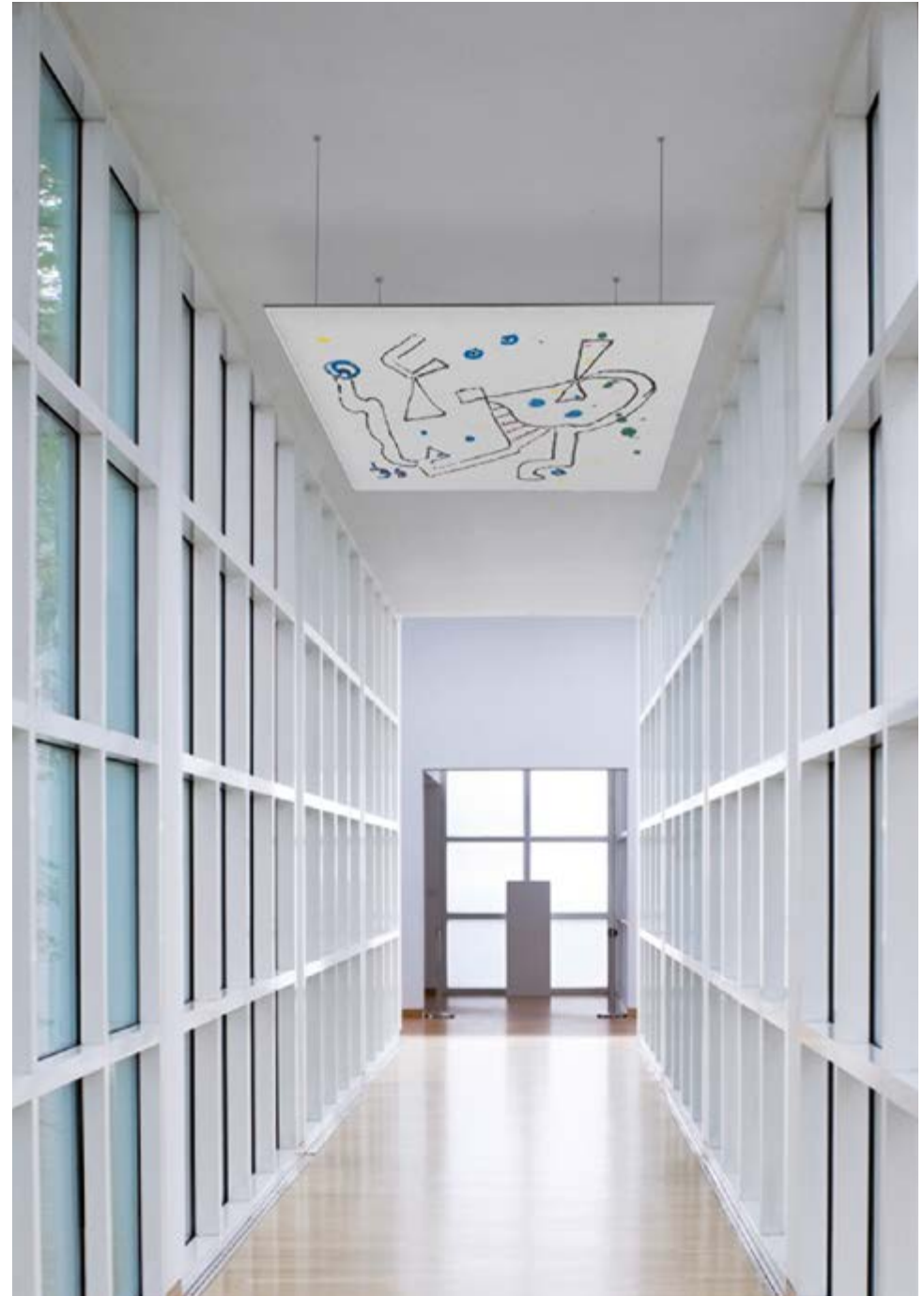

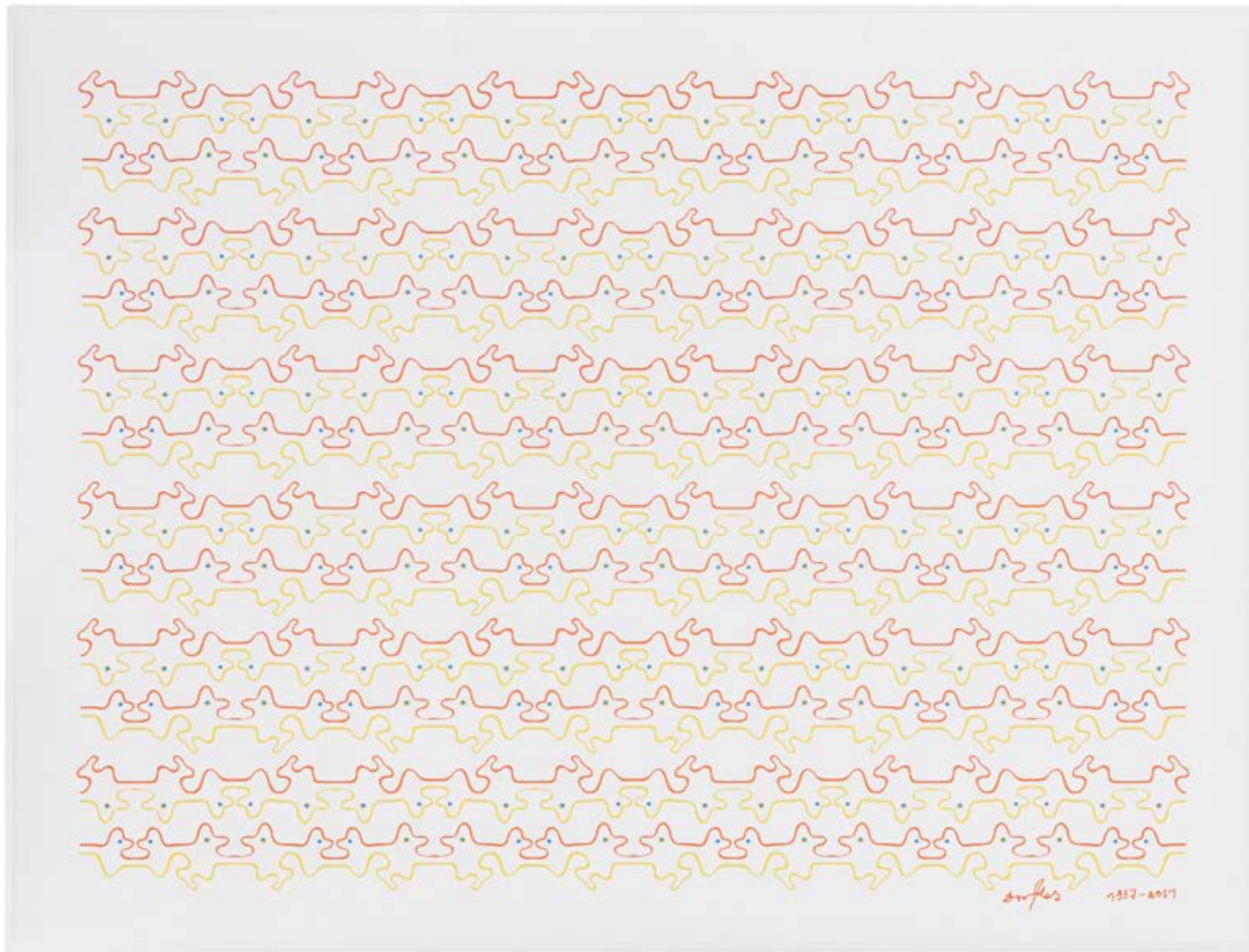

UNTITLED, 1937-2017

Sound-absorbing Snowsound panel,
wall / ceiling, 119 x 159 cm



I Serie di pannelli fonoassorbenti Snowsound sulle quali sono riprodotti una serie di disegni di Gillo Dorfler, opere che vanno dal 1937 al 2017.

EN A group of Snowsound sound-absorbing panels that feature a series of designs by Gillo Dorfler. Works from 1937 to 2017.

F Une série de panneaux phono-absorbants Snowsound sur lesquels sont reproduits des dessins de Gillo Dorfler, des œuvres datant de 1937 à 2017.

D Eine Reihe von schallabsorbierenden Snowsound-Paneelen, auf denen Bilder von Gillo Dorfler zu sehen sind, die zwischen 1937 und 2017 gemalt wurden.

E Serie de paneles fonoabsorbentes Snowsound en los que se ha duplicado una serie de dibujos de Gillo Dorfler, obras de entre 1937 y 2017.



UNTITLED, 1937-2017

Sound-absorbing Snowsound panel,
wall, 159 x 119 cm

Snowsound Technology

Design

Blade

**Lorenzo
Damiani**

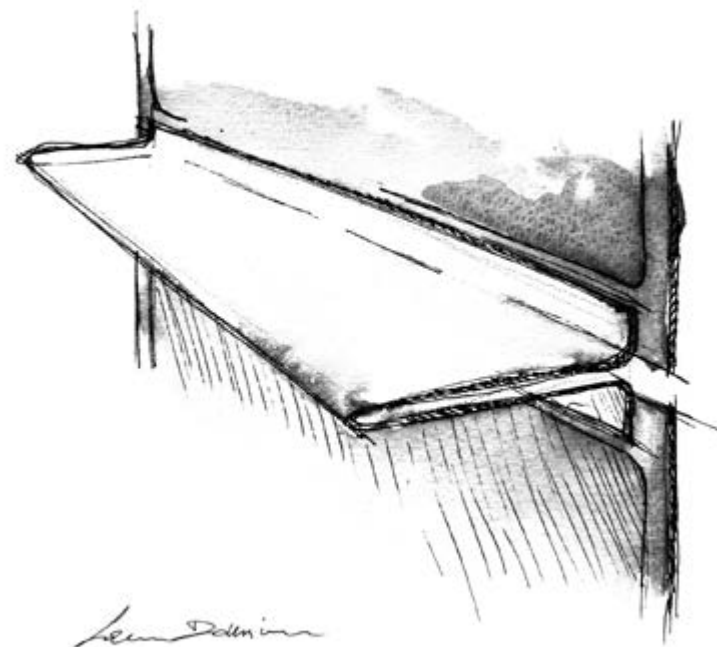



I Blade è un sistema di mensole componibili in altezza che utilizza come schienale i pannelli fonoassorbenti realizzati con tecnologia Snowsound. Le sottili mensole rendono l'immagine complessiva dell'oggetto molto leggera e minimalista. Le mensole, interamente realizzate in acciaio verniciato, sono composte da un'anima portante fissata a parete e da un rivestimento esterno (piano d'appoggio) molto sottile.

F Blade est un système d'étagères à hauteur composable qui utilise pour fond les panneaux phono-absorbants réalisés avec la technologie Snowsound. Les étagères très fines confèrent à l'objet une image d'ensemble particulièrement légère et minimaliste. Entièrement réalisées en acier peint, ces étagères se composent d'une âme portante fixée au mur et d'un revêtement extérieur (plan d'appui) très mince.



EN Blade is a system, modular in height, whose back consists of sound-absorbing panels made with Snowsound technology. Slim shelves create a visually light and minimalist overall image. The shelves are entirely made in epoxy powder-coated steel: a wall-mounted load-bearing core and a very thin external lining (support surface).

D Blade ist ein Regalsystem, das eine beliebige Höhe erreichen kann. Die Rückwand besteht aus schallabsorbierenden Paneelen, die sich auf die Snowsound-Technologie stützen. Aufgrund der hauchdünnen Regalbretter wirkt das Regal leicht und schlicht. Die Regalbretter sind gänzlich aus lackiertem Stahl. In ihrem Inneren befindet sich eine an der Wand fixierte tragende Seele, während sie außen mit einer sehr dünnen Beschichtung (Ablagefläche) gefertigt sind.

E Blade es un sistema de estantes modulares en altura cuyo respaldo está compuesto por paneles fonoabsorbentes realizados con la tecnología Snowsound. Gracias a sus estantes delgados, la imagen del objeto en su conjunto es muy ligera y minimalista. Los estantes, de acero barnizado, constan de un elemento de soporte que se fija a la pared y un revestimiento exterior (superficie de apoyo) muy delgado.



Snowsound Technology

Design

Corista

Lorenzo
Palmeri

Pinaxa Studio, Milano (Italy)

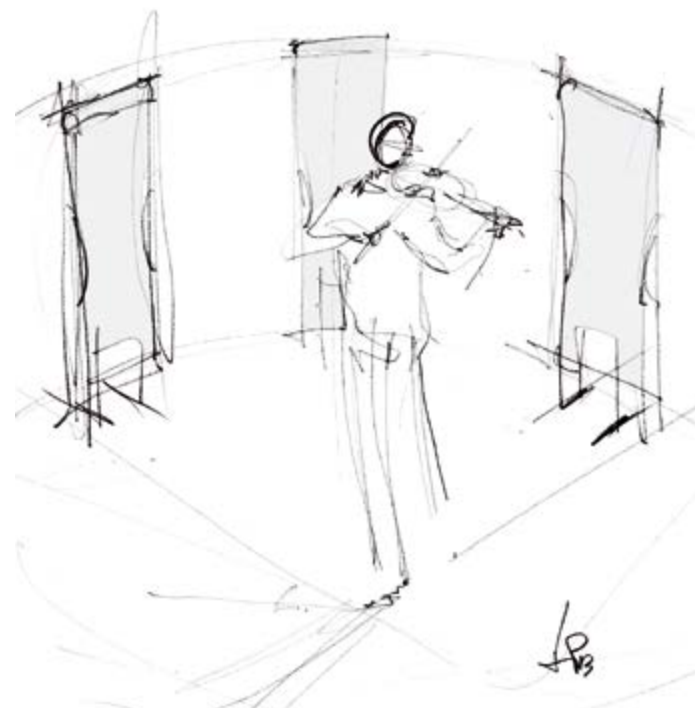

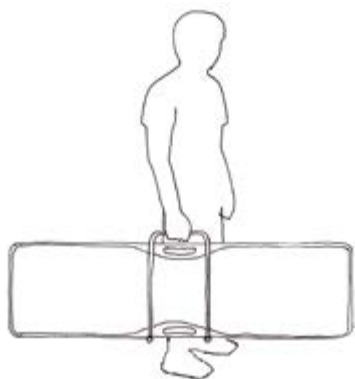

I “Corista è un elemento per la modulazione del suono, inizialmente pensato per una fascia di utenza specializzata: studi di registrazione, mixaggio, home recording, teatri o luoghi dove si improvvisano performance musicali. Ci siamo poi resi conto che è declinabile anche in altri ambiti: sale riunione, home theatre, ambienti per conferenze e seminari.”

EN “Corista is a product for sound modulation, initially designed for a specialised user group: recording and mixing studios, home recording, theatres or venues where musical performances can be improvised. We soon realised that it can be located beautifully in other areas - meeting rooms, home theatre, conference and seminar rooms.”

F “Corista est un élément de modulation du son, conçu en premier lieu pour une clientèle spécialisée: studios d’enregistrement, de mixage, studios amateurs, théâtres et lieux où s’improvisent des spectacles musicaux. Nous avons par la suite remarqué que Corista peut également être décliné dans d’autres environnements: salles de réunion, home cinéma, salles de conférence et de séminaire.”

D “Corista ist ein Element zur Klangmodulation, das anfangs für Fachnutzer geschaffen wurde: Aufnahmestudios, Soundmixer, Home Recording, Theater oder überall dort, wo Musikstücke improvisiert werden. Wir haben bemerkt, dass es auch an anderen Orten eingesetzt werden kann: Tagungsräume, Home Theater, Räumlichkeiten für Konferenzen und Seminare.”

E “Corista es un elemento para la modulación del sonido, inicialmente se había concebido para el sector de usuarios profesionales: estudios de grabación, mix, home recording, teatros o salas donde se representan espectáculos musicales. Después nos dimos cuenta que se puede aprovechar también en otros ámbitos: salas para reuniones, conferencias y seminarios, home theatre.”

Lorenzo Palmeri

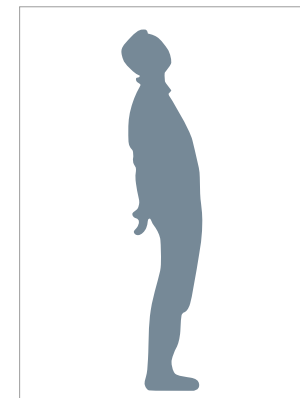

In**Caimi
Lab**

I I pannelli Snowsound In con dimensione 59x59 cm oppure 59x119 cm possono essere inseriti all'interno di controsoffitti dotati di profili e supporti idonei al supporto degli stessi. I pannelli sono muniti di marcatura CE ai sensi della norma di prodotto armonizzata EN 13964 per la destinazione di uso come controsoffitto.

F Les panneaux Snowsound In aux dimensions 59x59 cm ou 59x119 cm peuvent être insérés à l'intérieur de plafonds suspendus munis de profils et de supports aptes à les soutenir. Les panneaux sont munis du marquage CE aux termes de la norme de produit harmonisée EN 13964 pour l'emploi comme plafond suspendu.

EN Snowsound In panels, measuring 59x59 cm or 59x119 cm, can be inserted in suspended ceilings with profiles and supports that can hold them. The panels come with the CE mark according to the harmonised technical specification EN 13964 for use as a suspended ceiling.

D Die Snowsound In-Paneele mit den Maßen 59x59 cm bzw. 59x119 cm können in Rasterdecken mit Profilen und geeigneten Halterungen eingehängt werden. Die Paneele tragen die CE-Kennzeichnung entsprechend der harmonisierten Produktnorm EN 13964 für einen Einsatz als abgehängte Decke.

E Los paneles Snowsound In, con dos dimensiones, 59x59 cm y 59x119 cm, se pueden colocar dentro de los falsos techos con perfiles y soportes adecuados para su sostén. Los paneles llevan marca CE conforme a la norma de armonización EN 13964 sobre los productos que se utilizan en techos suspendidos.



Snowsound Fiber Products

pag. 10

**Design
& Designers**

- Alberto e Francesco Meda
- Atelier Mendini
- Sezgin Aksu
- Moreno Ferrari

pag. 06

**Research
& patents**



pag. 108

**Acoustic
performance**

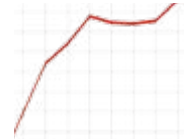

pag. 18

Greenguard
Gold



pag. 109

Eco-friendly



pag. 19

No formaldehyde



pag. 21

Fire



Snowsound Fiber Products

I La tecnologia brevettata Snowsound Fiber è basata su morbide fibre acustiche di poliestere intrinsecamente ignifughe e interconnesse tra loro. L'interazione fra le speciali fibre acustiche ed il design degli oggetti e dei sistemi di supporto permette di ridurre il fastidioso riverbero acustico negli ambienti, migliorando la qualità della vita e del lavoro.

EN The patented Snowsound Fiber technology is based on soft interwoven polyester acoustic fibers that are inherently fire-resistant. The interaction between the special acoustic fibers and the design of the objects and the support systems helps reduce annoying acoustic reverberation in rooms, while improving quality both of life and of work.

F La technologie brevetée Snowsound Fiber se base sur des fibres acoustiques très souples de polyester entrelacées et intrinsèquement ignifuges. L'interaction entre les spéciales fibres acoustiques et le design des objets et des systèmes de support permet de réduire la réverbération acoustique fastidieuse de la pièce et d'améliorer donc la qualité de vie et du travail.

D Die patentierte Technologie Snowsound Fiber basiert auf weichen, akustischen, innerlich feuerfesten und eng miteinander verbundenen Polyester-Fibern. Das Zusammenspiel aus diesen besonderen akustischen Fasern, dem Design der Objekte und den Befestigungssystemen ermöglicht es den unangenehmen Widerhall in Räumen zu verringern und dadurch sowohl die Lebensqualität als auch das Arbeitsumfeld zu verbessern.

E La tecnología patentada Snowsound Fiber se basa en suaves fibras acústicas de poliéster entrelazadas, intrínsecamente resistentes al fuego. La interacción entre las fibras acústicas especiales y el diseño de los objetos y de los sistemas de soporte logra atenuar la molesta reverberación acústica en los ambientes, mejorando la calidad de la vida y del trabajo.

Acoustic performance

I Il sistemi Snowsound Fiber sono stati testati secondo la norma UNI EN ISO 354. I grafici in funzione dell'applicazione sono disponibili nel sito www.caimi.com.

EN Snowsound Fiber has been tested to meet UNI EN ISO 354. The graphs for each application can be found on our website www.caimi.com.

F Les systèmes Snowsound Fiber ont été testés selon la norme UNI EN ISO 354. Les graphiques en fonction de l'application se trouvent sur le site www.caimi.com.

D Die Snowsound Fiber-Systeme sind gemäß der Norm UNI EN ISO 354 getestet worden. Die graphischen Darstellungen zur Anwendung sind auf der Homepage www.caimi.com einsehbar.

E Los ensayos de los sistemas Snowsound Fiber se realizaron según la norma UNI EN ISO 354. Los gráficos de las diferentes aplicaciones se pueden consultar en la página web: www.caimi.com.

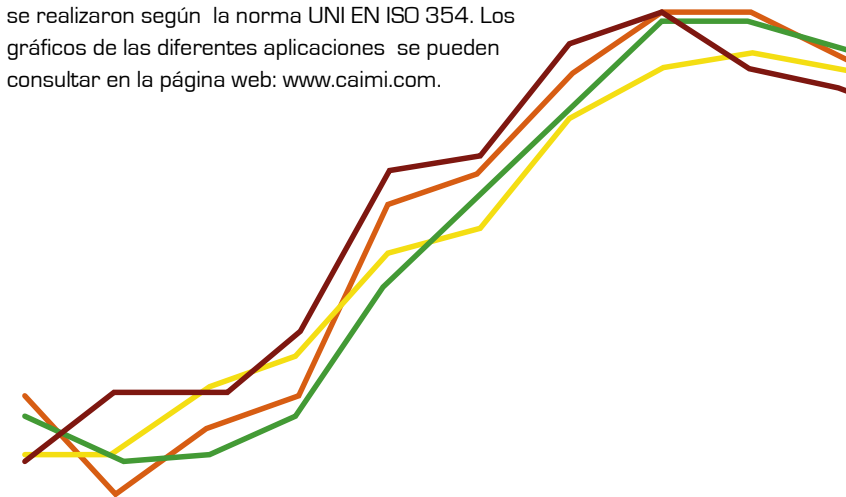

Eco-friendly

I Nella progettazione dei prodotti ci si è posti l'obiettivo di ottenere l'integrale riciclabilità del prodotto a fine vita, in modo semplice e rapido. Per questo motivo i prodotti Snowsound Fiber sono realizzati interamente in **poliestere riciclabile al 100%**. L'utilizzo di materiali e lavorazioni di alta qualità permette inoltre di allungare la vita dei prodotti con conseguente minor consumo di materiali ed energia. Snowsound Fiber non contiene feltri, lane o altri materiali di origine organica difficilmente riciclabili.

F La conception des produits a eu pour objectif d'obtenir la recyclabilité intégrale du produit au terme de sa vie, d'une manière simple et rapide. Motif pour lequel les produits Snowsound Fiber sont entièrement réalisés en **polyester recyclable à 100%**. L'utilisation de matériaux et une exécution de grande qualité permettent d'allonger la vie des produits ce qui implique une consommation inférieure de matériaux et d'énergie. Snowsound Fiber ne contient pas de feutres, laines ou autres matériaux d'origine organique difficilement recyclables.

EN The product design has set the objective of achieving comprehensive, simple and fast recyclability at the end of the useful life. This is why Snowsound Fiber is made entirely in **100% recyclable polyester**. The superior quality of the materials and workmanship extends the product life with the consequent decrease in materials and energy consumption. Snowsound Fiber does not contain felt, wool or other organic materials that might be difficult to recycle.

D Beim Entwerfen der Produkte wurde das Ziel verfolgt, die totale, einfache und schnelle Recyclingfähigkeit des Produktes nach endgültiger Außerbetriebnahme zu erreichen. Aus diesem Grunde sind Snowsound Fiber-Produkte gänzlich aus **100% recyclingfähigem Polyester** hergestellt. Der Einsatz von hochwertigen Materialien und Verarbeitungen erlaubt es darüber hinaus, das Produktleben zu verlängern und dadurch Material- und Energieverbrauch zu mindern. Snowsound Fiber enthält keine Filz- oder Wollstoffen und keine sonstigen schwer wiederzuverwertenden Materialien organischer Herkunft.

E Al diseñar los productos se estableció el objetivo de poder reciclarlos por completo al final de sus vidas, de forma sencilla y rápida. Por esta razón Snowsound Fiber se realizó totalmente en **poliéster reciclable al 100%**, incluyendo Velcro y el hilo de las costuras. También todos los componentes de metal son mono-material y fáciles de desmontar, pudiendo así reciclar todo el producto al 100%. Empleando materiales y procesos de elevada calidad se logra alargar la vida de los productos y, por consiguiente, gastar menos materiales y energía. Snowsound Fiber no contiene fieltros, lanas u otros materiales de origen orgánica difíciles de reciclar.



Vedi pag.18
See page 18



Diesis-Bemolle

Atelier
Mendini

I “Le speciali fibre con cui sono realizzati questi elementi esaltano l’assorbimento acustico, quando vengono realizzate delle curve o dei cilindri corrispondenti a precisi raggi e misure per ottenere delle esatte stratificazioni. È così allora che questi oggetti un po’ misteriosi hanno nella loro parte alta delle sagome di ferro precise, che poi permettono alle fibre di cadere assumendo l’aspetto di un tipico pannello. La morbidezza visiva di questi elementi li assimila alla delicatezza degli arredi tessili e, pertanto, all’immagine dei tendaggi e li rende adatti anche ad ambienti classici e dove non è possibile l’inserimento di forme rigide. Gli elementi Diesis e Bemolle da noi progettati, modulari e con misure adatte ad ottimizzare le performance, si presentano nello spazio come oggetti misteriosi, tanto è nuova e inusuale la loro tipologia nel settore degli oggetti acustici.”

EN “The special fibers of which these components are made augment the amount of acoustic absorption, since the curves or cylinders are based on precise ratios and measurements in order to obtain precise layers of fiber. Also, in the top of these rather mysterious objects are iron panels of a particular shape, which allow the fibers to hang in a way that makes them look like drapery. The visual softness of these components gives them something in common with the delicacy of textile furnishings and, as a result, also makes them suitable for use in classic environments where rigid shapes cannot be introduced. The Diesis (Sharp) and Bemolle (Flat) components we have designed are modular and can be made to the size which optimizes their performance. They look rather mysterious because they are a really new, unusual phenomenon in the acoustic sphere.”

D “Die besonderen Fasern, aus denen diese Elemente bestehen, unterstützen die Schalldämpfung. Kurven oder zylindrische Formen folgen genauen Linien und Maßen, um perfekte Schichten zu erreichen. So haben diese etwas mysteriösen Objekte im oberen Teil präzise Eisenprofile, die es den Fasern erlauben, so zu fallen, dass sie wie ein Faltenwurf aussehen. Die sichtbare Weichheit dieser Elemente erinnert an feine Einrichtungstextilien und somit an Vorhänge. Dadurch eignen sie sich auch für klassische Räume, in denen es nicht möglich ist, strenge Formen einzuführen. Die von uns entworfenen Elemente Diesis und Bemolle präsentieren sich mit ihrem Baukastensystem und den für eine optimale Leistung vorgesehenen Maßen als mysteriöse Objekte, die neu und ungewöhnlich für Gegenstände aus dem Bereich der Akustik sind.”

F “Les fibres spéciales qui ont servi à la réalisation de ces éléments exaltent l’absorption acoustique s’il est fait recours à des courbes ou à des cylindres correspondant à des rayons et à des mesures très précis pour obtenir des stratifications exactes. C’est ainsi que ces objets un peu mystérieux ont dans leur partie haute des formes en fer très précises qui permettent dès lors aux fibres d’acquiescer, en tombant, leur drapé typique. La douceur visuelle de ces éléments les assimile à la délicatesse de l’ameublement textile et donc à l’image des tentures, ce qui les rend parfaits même dans un cadre de style où la présence de formes rigides n’est pas tolérable. Les éléments Diesis et Bemolle que nous avons créés sont modulaires. Leurs dimensions sont faites pour optimiser les performances. Ils se présentent dans l’espace comme autant d’objets mystérieux tant leur typologie est nouvelle et inhabituelle dans le secteur des objets acoustiques.”

E “Las fibras especiales con que se han realizado estos elementos resaltan la absorción del sonido, cuando se realizan curvas o cilindros correspondientes a radios y medidas precisos para obtener estratificaciones precisas. Es así entonces como estos objetos un poco misteriosos tienen en su parte superior unas formas de hierro precisas, que hacen que las fibras puedan caer cobrando el aspecto de un típico drapeado. La suavidad visual de estos elementos los asemeja a la delicadeza de las decoraciones textiles y, por lo tanto, a la imagen de los cortinajes, y hace que resulten adecuados incluso a ambientes clásicos y allí donde no pueden introducirse formas rígidas. Los elementos Diesis y Bemolle que hemos diseñado, modulares y con unas medidas ideales para optimizar las prestaciones, se presentan en el espacio como objetos misteriosos, así de nueva e inusitada es su tipología en el sector de los objetos acústicos.”

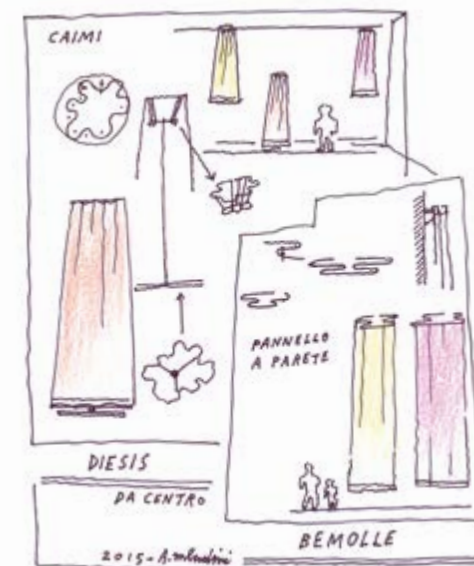

Diesis





Bemolle

I Diosis e Bemolle sono elementi fonoassorbenti realizzati con strutture portanti in acciaio e drappi realizzati con tecnologia Snowsound Fiber. Questi "oggetti" hanno nella loro parte alta dei telai in acciaio che consentono al drappaggio di cadere assumendo precisi raggi e stratificazioni studiate per ottimizzare le performance acustiche. Diosis è disponibile nella versione a soffitto oppure free-standing. Bemolle è concepito per il fissaggio a parete, le sue curve a "U" generano tre strati di tessuto opportunamente distanziati fra di loro detti stratificazioni. Bemolle è disponibile anche nella versione dotata di lampada interna a LED, con illuminazione indiretta verso l'alto.

EN Diosis and Bemolle are sound-absorbing elements with steel base and drapes based on Snowsound Fiber technology. These pieces feature steel frames at the top that create the sound-absorbing drape, thus assuming precise rays and layers, designed to optimise acoustic performance. Diosis is available in both ceiling mounted or free-standing versions. Bemolle is designed for wall-mounting. Its "U" curves create three layers of fabric designed specifically for optimal performance. Bemolle is also available with an internal LED element (offering indirect upper illumination).

F Diosis et Bemolle sont des éléments phono-absorbants réalisés avec des structures portantes en acier et des draps fabriqués avec la technologie Snowsound Fiber. La partie haute de ces "objets" est faite de châssis en acier permettant un drapé qui suit des rayons et des stratifications étudiés en vue d'optimiser les performances acoustiques. Diosis existe dans la version plafond ou free-standing. Bemolle est prévu pour être appliqué au mur. Ses courbes en forme de "U" forment trois couches de tissu savamment distancées les unes des autres, dites stratifications. Bemolle est également disponible dans la version avec lampes internes à LED, pour un éclairage indirect vers le haut.

D Diosis und Bemolle sind schallabsorbierende Elemente, die mit Stahlträgern und Textilbezügen, die sich auf die Snowsound Fiber-Technologie stützen, ausgestattet sind. Im oberen Teil haben diese "Objekte" Stahlprofile, die es den Textilbezügen erlauben, so zu fallen, dass sie präzise Räden und Schichtungen erzielen, die für eine optimale akustische Performance erforderlich sind. Diosis kann sowohl freistehend als auch an der Decke montiert angewendet werden. Bemolle befestigt man hingegen an der Wand. Die U-förmigen Wellen bilden die oben erwähnten Schichtungen, die wiederum aus drei, voneinander getrennten Textilschichten bestehen. Bemolle ist auch mit integrierter LED-Lampe erhältlich, die ein indirektes Licht an die Decke wirft.

E Diosis y Bemolle son elementos fonoasorbentes realizados con estructuras de soporte de acero y telas fabricadas con tecnología Snowsound Fiber. Estos "objetos", en la parte superior, tienen unos bastidores de acero para drapear la tela que cae con pliegues precisos y estratificaciones concebidas para optimizar el rendimiento acústico. Diosis tiene dos versiones: para colgar del techo y autoportante. Bemolle se concibió para sujeción a pared, sus curvas en "U" forman tres capas de tela con una distancia apropiada entre ellas que se llaman estratificaciones. Bemolle también tiene un modelo equipado con lámpara interior LED, de iluminación indirecta hacia arriba.

Bemolle lux



Snowsound Fiber Products

Design

Sipario

Alberto Meda
Francesco Meda



I l sistema fonoassorbente Sipario è costituito da pannelli modulari con struttura in acciaio e superficie sfoderabile e lavabile, realizzata con tecnologia Snowsound Fiber applicata mediante velcro alla struttura stessa. La struttura è applicata a parete mediante fissaggi in metallo cromato dotati di particolari molle che rendono la struttura elastica, tali supporti consentono anche la regolazione della distanza dalla parete e l'inclinazione dei pannelli, consentendo di variare l'assorbimento acustico di ogni configurazione, adattandola alle diverse esigenze. La componibilità dei pannelli consente di creare diverse configurazioni, lasciando libertà interpretativa al progettista.

F Le système phono-absorbant Sipario est constitué de panneaux modulaires avec structure en acier et une surface déhoussable et lavable, produite avec la technologie Snowsound Fiber et appliquée à la structure par velcro. La structure est appliquée au mur à l'aide de fixations en métal chromé, dotées de ressorts spéciaux qui la rendent élastique. Ces supports permettent notamment de régler la distance du mur et l'inclinaison des panneaux permettant ainsi de varier l'absorption acoustique de chaque configuration et de l'adapter aux différentes exigences. La composition des panneaux par éléments permet de créer différentes configurations et de laisser au projeteur toute sa liberté d'interprétation.

D Das schallabsorbierende System Sipario besteht aus modularen Paneelen mit Stahlstruktur und abziehbarem bzw. waschbarem Textilbezug. Dieser Bezug wird mit Snowsound Fiber-Technologie geschaffen und durch einen Klettverschluss an der Struktur befestigt. Die Struktur verfügt über Wandhalterungen aus verchromtem Metall, die besondere Federn haben; dadurch wird die Struktur elastisch. Die Halterungen ermöglichen außerdem den Abstand von der Wand und den Neigungswinkel der Paneele zu bestimmen, sodass die akustische Absorption jeder Kreation unterschiedlich ausfällt und auf die verschiedenen Bedürfnisse abgestimmt werden kann. Das Zusammenbauen der Paneele erlaubt viele verschiedene Gestaltungsmöglichkeiten und lässt dem Planer daher viel Freiraum für Kreativität.

E El sistema fonoabsorbente Sipario está compuesto por paneles modulares con estructura de acero y superficie desenfundable y lavable, realizada con tecnología Snowsound Fiber que se aplica con velcro a la estructura misma. La estructura se sujeta a la pared con fijaciones de metal cromado equipadas con resortes especiales para que la estructura resulte más elástica. Con dichos soportes se puede también ajustar la distancia a la pared y la inclinación de los paneles, para modificar la absorción acústica de cada configuración, adaptándola a las diferentes exigencias. Los paneles componibles nos ofrecen la posibilidad de crear configuraciones diferentes, dejando libertad de interpretación al diseñador.

EN Sipario sound-absorbing system is made of modular panels with steel frame and washable, removable covering, made with Snowsound Fiber technology applied with Velcro to the structure. The structure is anchored to the wall by chrome-plated metal clamps equipped with special springs that give the structure elasticity while also making it possible to adjust the distance from the wall and the tilt of the panels, to regulate the sound-absorption level of every configuration, adapting it to a variety of needs. The composition of the panels creates a diversity of configurations, allowing the designer ample freedom of interpretation.



Snowsound Fiber Products

Design

Palio

Sezgin
Aksu

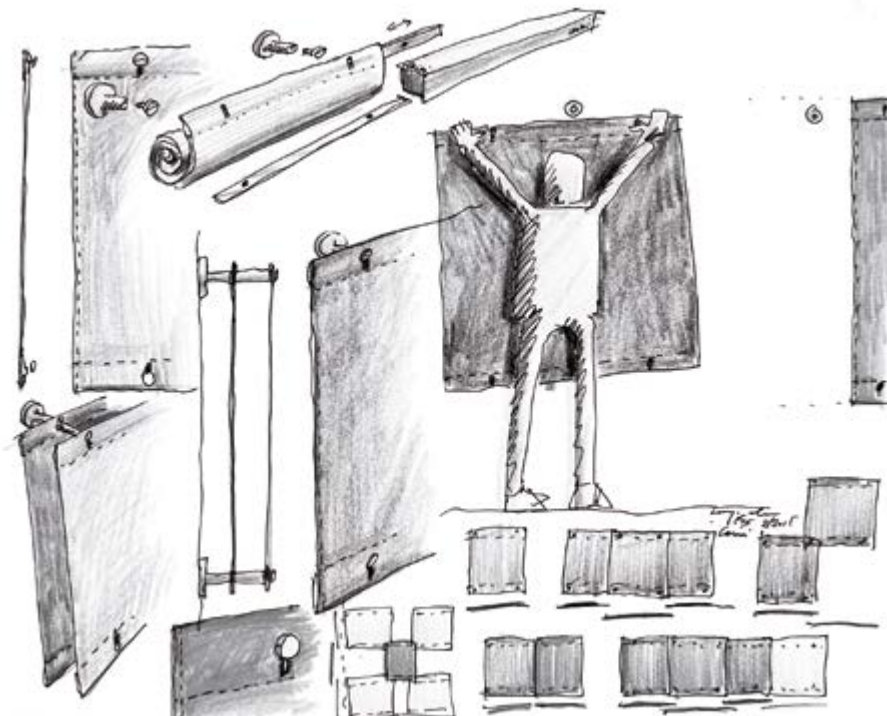



I Il sistema fonoassorbente Palio è costituito da pannelli asportabili e lavabili realizzati con tecnologia Snowsound Fiber e da supporti in metallo. I fissaggi a parete in metallo cromato sono dotati di particolari molle che rendono la struttura elastica. Tali supporti consentono la regolazione della distanza dalla parete, permettendo di variare l'assorbimento acustico di ogni configurazione adattandola alle diverse esigenze.

F Le système phono-absorbant Palio est constitué de panneaux amovibles et lavables, réalisés avec la technologie Snowsound Fiber, et de supports métalliques. Les fixations murales en métal chromé sont équipées de ressorts spéciaux qui rendent la structure élastique. Ces ressorts permettent le réglage de leur distance du mur, permettant de varier l'absorption acoustique de chaque configuration et l'adapter aux différentes exigences.

D Das schallabsorbierende System Palio besteht aus abmontierbaren und waschbaren Paneelen, die mit der Snowsound-Technologie hergestellt werden. Die Paneele sind außerdem mit Metallhalterungen ausgestattet. Die Wandhalterungen aus verchromtem Metall haben besondere Federn, die die Struktur elastisch machen. Diese Halterungen ermöglichen außerdem den Abstand von der Wand, zu bestimmen, sodass die akustische Absorption jeder Kreation unterschiedlich ausfällt und auf die verschiedenen Bedürfnisse abgestimmt werden kann.

E El sistema fonoabsorbente Palio está compuesto por paneles desmontables y lavables realizados con tecnología Snowsound Fiber y por soportes de metal. Puesto que las fijaciones de pared de metal cromado están equipadas con resortes especiales la estructura es elástica. Con dichos soportes se puede también ajustar la distancia a la pared para modificar la absorción acústica de cada configuración, adaptándola a las diferentes exigencias.

EN Palio sound-absorbing system is consisting of removable, washable panels, made with Snowsound Fiber technology, and a metal frame. Chrome-plated metal clamps are equipped with special clamps that give the structure elasticity while also making it possible to adjust the distance from the wall and regulate the sound-absorption level of every configuration, adapting it to a variety of needs.



Snowsound Fiber Products

Design

Si Sboccia

Moreno
Ferrari



I Si Sboccia è un oggetto fonoassorbente realizzato con Snowsound Fiber, disponibile nella versione a parete o sospesa a soffitto. Una rosa di grandi dimensioni, nata dalla capacità del designer Moreno Ferrari di vedere oltre le cose: da un bocciolo di rosa trovato per caso, si è sviluppata l'idea di un prodotto utile ed emozionale al tempo stesso, in grado di arredare e caratterizzare gli ambienti rendendoli nel contempo acusticamente confortevoli.

EN Si Sboccia is a sound-absorbing object created with Snowsound Fiber, available for wall-mounting or ceiling suspension. Designer Moreno Ferrari's ability to see beyond mere objects has resulted in this large rose. From his fortuitous find of a rosebud, he came up with the idea of a product that is both useful and exciting, capable of decorating and characterizing environments while making them acoustically comfortable at the same time.

F Si Sboccia est un objet phono-absorbant réalisé avec Snowsound Fiber, disponible dans la version murale ou suspendue au plafond. Une rose de grandes dimensions, née grâce à la capacité du designer Moreno Ferrari de voir au-delà des choses : à partir d'un bouton de rose trouvé par hasard, est née l'idée d'un produit utile et émotionnel en même temps, en mesure de décorer et de personnaliser les intérieurs en assurant en même temps leur confort acoustique.

D Si Sboccia ist ein schallabsorbierendes Designobjekt mit Snowsound Fiber, das in einer Wand- oder Decken-version erhältlich ist. Diese riesige Rose entspringt der Fähigkeit des Designers Moreno Ferrari hinter die bloßen Objekte zu blicken: Die Knospe einer Rose, die er zufällig fand, inspirierte ihn zu seiner Idee für ein Produkt, das nützlich und bezaubernd zugleich ist und das einen Raum einzigartig dekoriert und gleichzeitig für akustischen Komfort sorgt.

E Si Sboccia es un objeto fonoabsorbente realizado con Snowsound Fiber, hay un modelo mural y otro colgante para techo. Es una rosa de gran tamaño, que concibió el diseñador Moreno Ferrari: de un capullo de rosa que se plasmó al azar, se fue desarrollando la idea de un producto útil y también emotivo, que lograrse decorar y personalizar los ambientes ofreciendo, además, confort acústico.

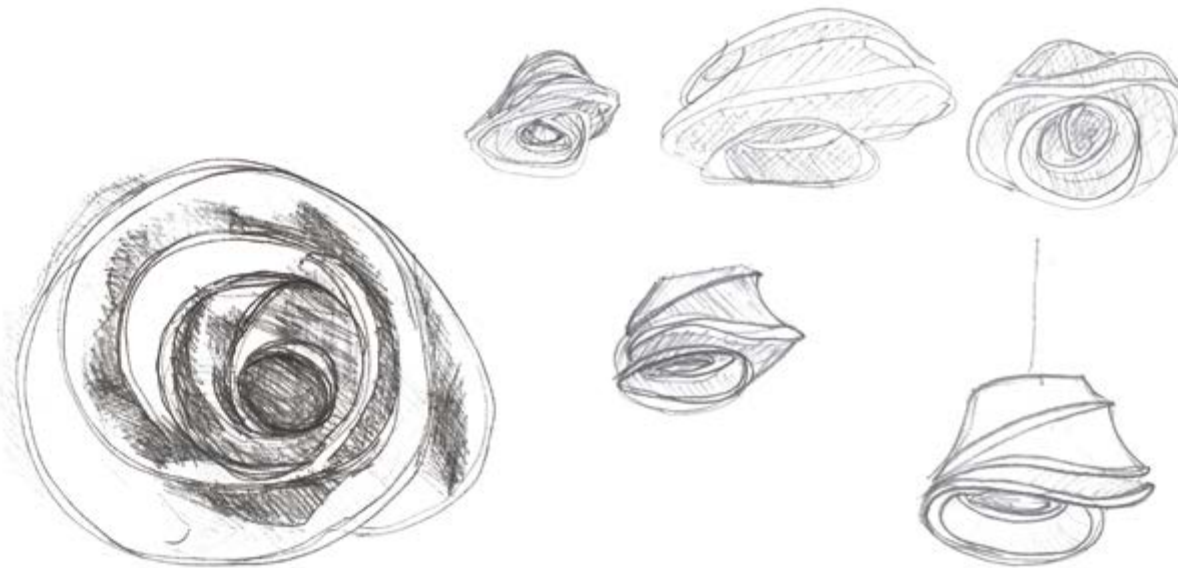





Snowsound Extra

Design

Snowsofa

Sezgin
Aksu



I Snowsofa è un divano acustico a schienale alto pensato per garantire un comfort a tutto tondo nei momenti di pausa e di relax, fondendo comodità, ergonomia e benessere acustico in un unico oggetto d'arredo.

F Snowsofa est un canapé acoustique avec dossier haut conçu pour garantir un confort total pendant les moments de pause et de détente, assurant confort, ergonomie et bien-être acoustique en un seul meuble.

EN Snowsofa is an acoustic, high back sofa, designed to offer all-round comfort during breaks merging ease ergonomics and acoustic well-being in a single piece of furniture.

D Snowsofa ist eine akustische Couch mit hoher Rückenlehne, die dazu entwickelt wurde, sich in Momenten der Ruhe und Entspannung rundum wohl zu fühlen. Es vereint Bequemlichkeit, Ergonomie und akustischen Komfort in einem einzigen Möbelstück.



E Snowsofa es un sofá acústico con respaldo alto concebido para garantizar un confort total en los momentos de pausa y de relax, acoplando comodidad, ergonomía y bienestar acústico en un objeto de decoración único.



I La tenda arricciata che caratterizza l'oggetto è realizzata con tessuto acustico Snowsound Fiber, materiale che permette di garantire privacy e comfort sia visivo che acustico, senza creare i fastidiosi effetti eccessivamente ovattati.

EN The pleated curtain that characterizes this product is manufactured using Snowsound Fiber acoustic fabric, which is a material that guarantees privacy and comfort, both visual and acoustic, without creating bothersome muffled effects.

F Le rideau plissé qui caractérise l'objet est réalisé avec le tissu acoustique Snowsound Fiber. Un matériau qui permet de garantir la discrétion et le confort visuel et acoustique, sans créer des effets excessivement feutrés et gênants.

D Der Plissee-Vorhang, durch den sich der Einrichtungsgegenstand auszeichnet, besteht aus dem akustisch wirksamen Stoff Snowsound Fiber, einem Material, das für Privatsphäre und Komfort in ästhetischer und akustischer Hinsicht sorgt, ohne dabei das unangenehme Gefühl einer übermäßigen Dämpfung zu vermitteln.

E La cortina fruncida que caracteriza este objeto se realizó con tela de absorción acústica Snowsound Fiber, material que logra garantizar privacidad y confort tanto visual como acústico, sin crear el molesto y excesivo efecto de amortiguación.





Snowsound Extra

Design

Cocker

Caimi
Lab

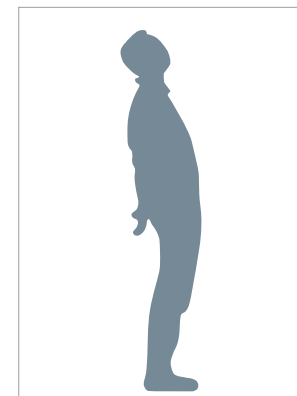

I Cocker è un confortevole phone booth composto da un'imbottitura interna in poliesteri morbida e fonoassorbente, da un rivestimento in poliesteri Trevira CS[®] completamente sfoderabile e da una struttura portante indipendente, realizzata in tondino d'acciaio cromato. I fianchi morbidi e mobili sono appositamente studiati per muoversi liberamente se urtati accidentalmente.

EN Cocker is a comfortable phone booth composed by an internal padding in sound-absorbing polyester foam covered in Trevira CS[®] polyester which is completely removable. It also features an independent load-bearing frame in tubular chrome-plated steel. The soft, moveable sides have been specifically designed to move freely if accidentally bumped.

F Cocker est une cabine confortable composée d'un rembourrage interne en polyester souple et phono-absorbant, d'un revêtement en polyester Trevira CS[®] entièrement amovible ainsi que d'une structure portante indépendante réalisée en tiges d'acier chromé. Les parois souples et mobiles ont été étudiées afin de bouger en toute liberté en cas de heurt accidentel.

D Cocker ist eine bequeme Telefonzelle, die innen mit weichem schalldämpfenden Polyester gepolstert ist und mit einem komplett abziehbaren Trevira CS[®]-Bezug verkleidet ist. Die unabhängige Struktur besteht aus verchromtem Rundstahl. Die weichen und beweglichen Seitenflächen wurden so gestaltet, dass sie nachgeben, wenn sie versehentlich angestoßen werden.

E Cocker es una confortable cabina acústica compuesta por un acolchado interior de poliéster suave y acústico absorbente, por un forro de poliéster Trevira CS[®] que se puede quitar por completo y por una estructura de sostén independiente, de hilo de acero cromado. Los lados blandos y móviles se concibieron específicamente para que se puedan mover libremente al chocar casualmente contra ellos.



Snowsound Extra

Design

Snowall

Caimi
Lab

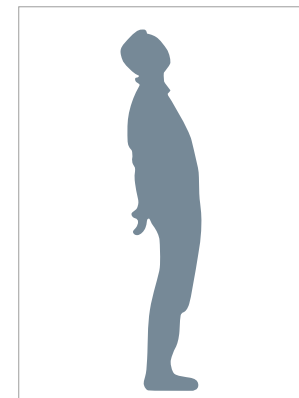

I Snowall è composto da un feltro di poliestere al quale viene applicato mediante un particolare sistema di fissaggio un tessuto in poliestere Trevira CS®. Il rivestimento in tessuto del feltro e l'assenza di intercapedini tra i due materiali, riducono notevolmente la possibilità di accumulare polveri, pollini o di ospitare insetti. Snowall ha Classe di reazione al fuoco Euroclass B-s2, d0. Snowall ha contenuto di formaldeide non rilevabile, test eseguito secondo la norma UNI EN 717-2.

EN Snowall is made up of polyester felt paired with a polyester Trevira CS® material using a unique application system. The felt lining and the absence of space between the two materials significantly reduces its propensity to attract dust, pollen and insects. Snowall has Euroclass B-s2, d0 classification as to reaction to fire. Snowall has no detectable formaldehyde contents, tested according to the UNI EN 717-2.

F Snowall est composé d'un feutre en polyester auquel est appliqué, par un système de fixation particulier, un tissu en polyester Trevira CS®. Le revêtement en tissu du feutre et l'absence d'interstices entre les deux matériaux, réduisent considérablement la possibilité d'accumuler des poussières, des pollens ou d'abriter des insectes. Snowall est Euroclass B-s2, d0 pour la réaction au feu.

La teneur en formaldéhyde de Snowall est non détectable; test effectué conformément à la norme UNI EN 717-2.

D Snowall besteht aus Polyesterfilz, der durch ein besonderes Applikationsverfahren mit dem Polyesterstoff Trevira CS® kombiniert wird. Der Unterstoff aus Filz sowie die Tatsache, dass zwischen den beiden Materialien keine Zwischenräume bestehen, reduzieren die Anfälligkeit für Staub-, Pollen- bzw. Insektenansammlung. Snowall entsprechen der Euroklasse B-s2, d0 für feuerfeste Materialien. Formaldehyd ist in Snowall nicht messbar, der Test wurde gemäß der Norm UNI EN 717-2.

E Snowall está compuesto por un fieltro de poliéster al que se le aplica, mediante un sistema de fijación especial, un tejido de poliéster Trevira CS®. Forrando el fieltro con el tejido sin dejar intersticios entre los dos materiales, se limita notablemente la posibilidad de que se acumule polvo, polen o que se alojen insectos. Snowall posee Euroclass B-s2, d0 de reacción al fuego. Snowall tiene un contenido no detectable de formaldehído, prueba llevada a cabo conformemente a la norma UNI EN 717-2.

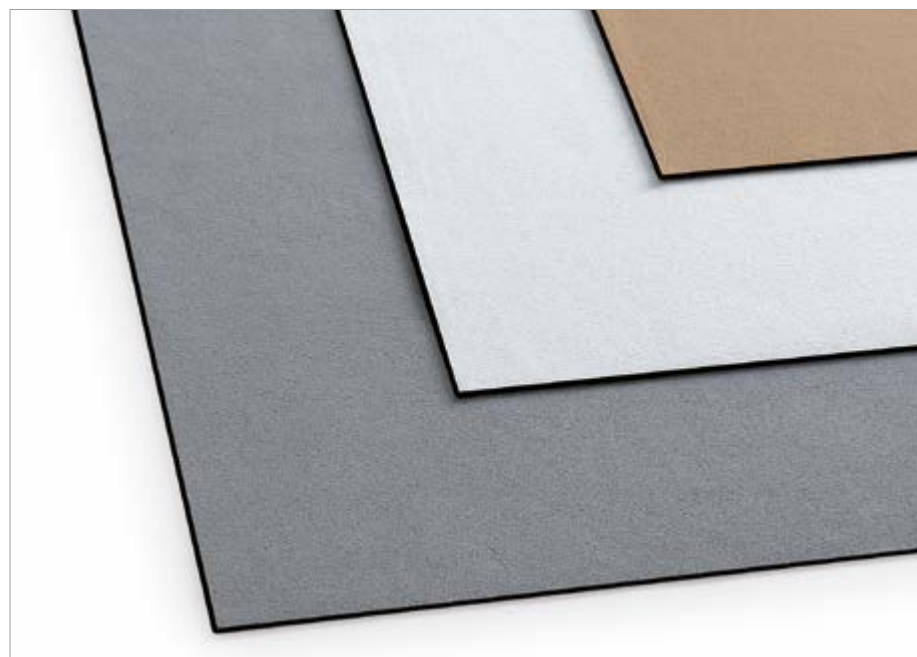

Snowsound Fiber Textiles

I La tecnologia brevettata Snowsound Fiber è basata su morbide fibre acustiche di poliestere intrinsecamente ignifughe e interconnesse tra loro. L'interazione tra le fibre di Snowsound Fiber e l'aria, permette di controllare il riverbero regolando con precisione la risposta acustica dell'ambiente in base alle modalità di posa, alla superficie e alla distanza tra le fibre e la parete, consentendo di ridurre il fastidioso riverbero acustico negli ambienti, migliorando la qualità della vita e del lavoro.

La scelta dei diversi tipi di materiale Snowsound Fiber e la modalità di installazione, consentono di poter privilegiare l'assorbimento di specifiche frequenze (basse, medie o alte) o di assorbire diverse frequenze in modo uniforme. Il comportamento di Snowsound Fiber, in base al materiale e alle modalità di installazione, varia in termini di classe di assorbimento che può raggiungere la classe A.

Il catalogo completo Snowsound Fiber Textiles può essere scaricato dal sito www.caimi.com.

EN The patented Snowsound Fiber technology is based on soft interwoven polyester acoustic fibers that are inherently fire-resistant. The interaction between Snowsound Fiber and air allows controlling reverberation while adjusting the environment's acoustics with precision taking advantage of installation modes, product's surface and distance from the wall. This reduces the annoying acoustic reverberation improving quality both of life and of work. The choice of different Snowsound Fiber materials and the installation modes allow a selective absorption at precise ranges (low, medium, high) or a more uniform absorption at all frequencies. Snowsound Fiber's behavior varies based on the selected material and the installation mode and can reach A class for sound absorption. The complete Snowsound Fiber Textiles catalogue can be downloaded at www.caimi.com.

F La tecnologia brevettata Snowsound Fiber se base sur des fibres acoustiques très souples de polyester entrelacées et intrinsecament ignifuges. L'interaction entre les fibres de Snowsound Fiber et l'air permet de contrôler la réverbération en réglant avec précision la réponse acoustique de l'espace selon la méthode d'installation, la surface et la distance entre les fibres et le mur. Ainsi faisant on réduit la réverbération acoustique fastidieuse de la pièce en améliorant donc la qualité de vie et du travail. Le choix des différents types de matériaux Snowsound Fiber et le mode d'installation, permettent de favoriser l'absorption de fréquences spécifiques (basses, moyennes ou hautes) ou absorber des fréquences différentes de façon égale. Le comportement de Snowsound Fiber, en fonction du matériel et mode d'installation, change pour ce qui concerne la classe d'absorption, qui peut atteindre la classe A. Le catalogue complet Snowsound Fiber Textiles peut être téléchargé sur le site www.caimi.com.

D Die patentierte Technologie Snowsound Fiber basiert auf weichen, akustischen, innerlich feuerfesten und eng miteinander verbundenen Polyester-Fibern. Die Interaktion zwischen den Snowsound Fibern und der Luft erlaubt es, den Widerhall zu kontrollieren und die akustische Antwort des Raums auf der Grundlage des Verlegungsmodus, der Fläche und der Distanz zwischen Fibern und Wand präzise zu regulieren, und somit den störenden Widerhall von Räumen zu verringern und dadurch die Lebens- und Arbeitsqualität zu verbessern. Die Wahl von unterschiedlichen Typen von Snowsound Fiber-Material und Verlegungsmodi erlaubt es, die Absorption von bestimmten (niedrigen, mittleren oder höheren) Frequenzbereichen bzw. die homogene Absorption von verschiedenen Frequenzbereichen zu bevorzugen. Je nach Material und Verlegungsmodus variiert das Verhalten von Snowsound Fiber hinsichtlich der Schall-Absorptionsklasse, die bis zur A-Klasse reichen kann. Der vollständige Katalog von Snowsound Fiber Textiles ist als Download unter www.caimi.com erhältlich.

Experience the difference



Without/With
Snowsound
Fiber Textiles

E La tecnología patentada Snowsound Fiber se basa en suaves fibras acústicas de poliéster entrelazadas, intrinsecamente resistentes al fuego. La interacción entre Snowsound Fiber y el aire permite controlar la reverberación mientras ajusta la acústica del entorno con precisión, aprovechando los modos de instalación, la superficie del producto y la distancia desde la pared. Esto atenúa la molesta reverberación acústica en los ambientes, mejorando la calidad de la vida y del trabajo. La elección de los diferentes materiales Snowsound Fiber y los modos de instalación permiten una absorción selectiva a intervalos precisos (baja, media, alta) o una absorción más uniforme en todas las frecuencias. El comportamiento de Snowsound Fiber varía según el material seleccionado y el modo de instalación y puede alcanzar una clase A para la absorción acústica. El catálogo completo Snowsound Fiber Textiles se puede bajar de la página web www.caimi.com.



Projects

134 . 174 . 190 . 200 . 206 . 234 . 240

Office

Public spaces
& Museums

Education
& Schools

Retail
& Leisure

Restaurants,
Cafès & Hotels

Home

Audio
& Music

Projects

Office



Product: SIPARIO



Products: OVERSIZE LUX, FIBER 2R and FIBER 8

Products: OVERSIZE LUX, BLADE and FIBER 8



Product: BLADE



Medtronic Italia, Milano (Italy)
Product: OVERSIZE







Criteo, Milano (Italy)
Products: FLAP, V-FLAP and BAFFLE

Criteo, Milano (Italy)
Products: FLAP and OVERSIZE



Product: FLAP



Product: DIESIS



Product: MITESCO





Conference room (Italy)
Product: OVERSIZE



Hjelle, Oslo (Norway)
Product: FLAP

Meeting room, Los Angeles (U.S.A.)
Product: FLAP



Office, Los Angeles (U.S.A.)
Product: FLAP



Conference room, Los Angeles (U.S.A.)
Product: MITESCO



Office, Denver (U.S.A.)
Product: V-FLAP



Product: SNOWSOUND ART





AXA Assicurazioni, Milano (Italy)
Product: MITESCO



AXA Assicurazioni, Milano (Italy)
Product: MITESCO





Product: FLAP



Product: MITESCO



150

151



OfficeScapes, Denver (U.S.A.)
Product: FLAP

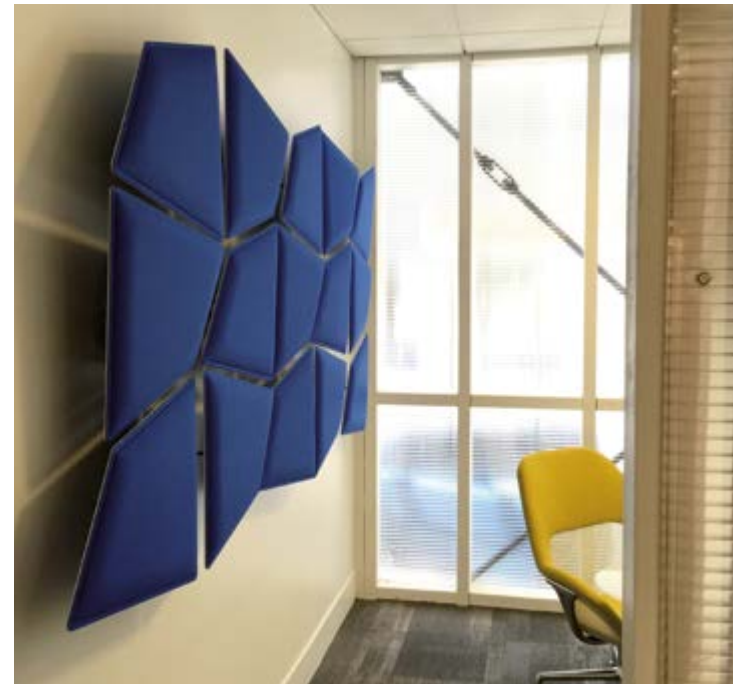

Tangram Interiors, Santa Fe Springs (U.S.A.)
Product: FLAP





Product: MITESCO



Product: SIPARIO



Heineken (Italy)
Product: MITESCO

Product: PALIO



Office (U.S.A.)
Product: PLI

Product: MITESCO





Technical Center, Tokyo (Japan)
Product: MITESCO

Product: OVERSIZE



Technical Center, Tokyo (Japan)
Product: MITESCO





Elsy Studios, Denver (U.S.A.)
Product: FLAP



Product: BAFFLE OVERSIZE

Office, design by AECOM, Los Angeles (U.S.A.)
Product: FLAP



Product: FLAP



158
159

Fincontatto, Napoli (Italy)
Products: CORNER and IN





Product: MITESCO



Cinecittà studi cinematografici, Roma (Italy)
Product: MITESCO

Nasdaq OMX, Paris (France)
Product: MITESCO



Xerox (Italy)
Product: MITESCO



SONY, CBRE Building, Chicago (U.S.A.)
Product: FLAP



Product: FLAP

Office building, Johannesburg (South Africa)
Product: BAFFLE

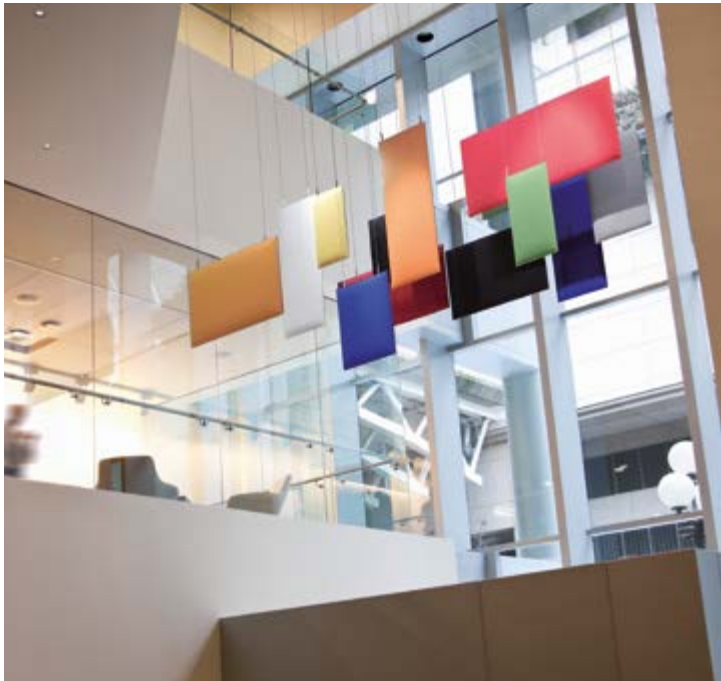

Product: BAFFLE





Product: MITESCO



166
167



Products: SNOWSOUND ART and SNOWFIX



01



03



06



07



02



04

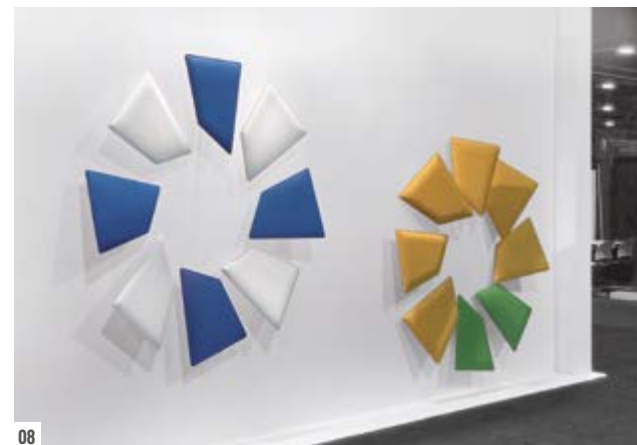

08



05



09



10

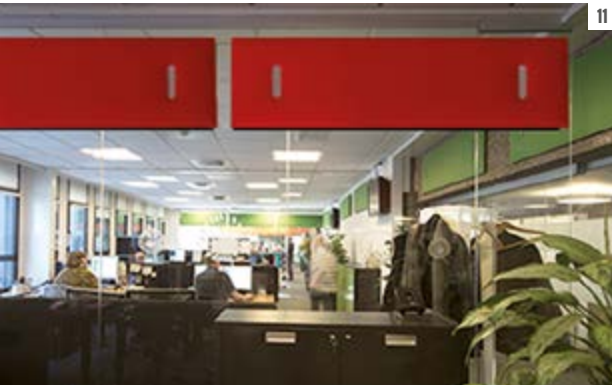

11



13



12



14



15

01_ Zero-z design (Netherlands)
Product: FLAP

02_ AXA Assicurazioni, Paris (France)
Product: FLAP

03_ Wind, Roma (Italy)
Product: SNOWALL

04_ Slovenska Industrija Jekla (Slovenia)
Products: MITESCO and IN

05_ AXA Assicurazioni, Brescia (Italy)
Product: MITESCO

06_ NeoCon, Seminar Rooms, Chicago (U.S.A.)
Product: MITESCO

07_ Nasdaq OMX, Oslo (Norway)
Product: MITESCO

08_ CEDIA, Denver (U.S.A.)
Product: FLAP

09_ Eden Viaggi, Pesaro (Italy)
Product: MITESCO

10_ Zapi, Conselve PD (Italy)
Product: MITESCO

11_ City Hall of Copenhagen (Denmark)
Product: MITESCO

12_ Office, San Francisco (U.S.A.)
Product: MITESCO

13_ Sparim, Bolzano (Italy)
Product: MITESCO

14_ Sureway Employment, Wagga Wagga (Australia)
Product: MITESCO

15_ Office, Johannesburg (South Africa)
Product: MITESCO

168

169



01



03

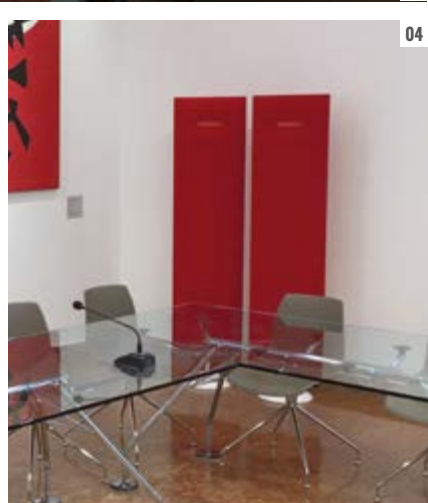

04



02



06



07



05



08



09



10



11



12

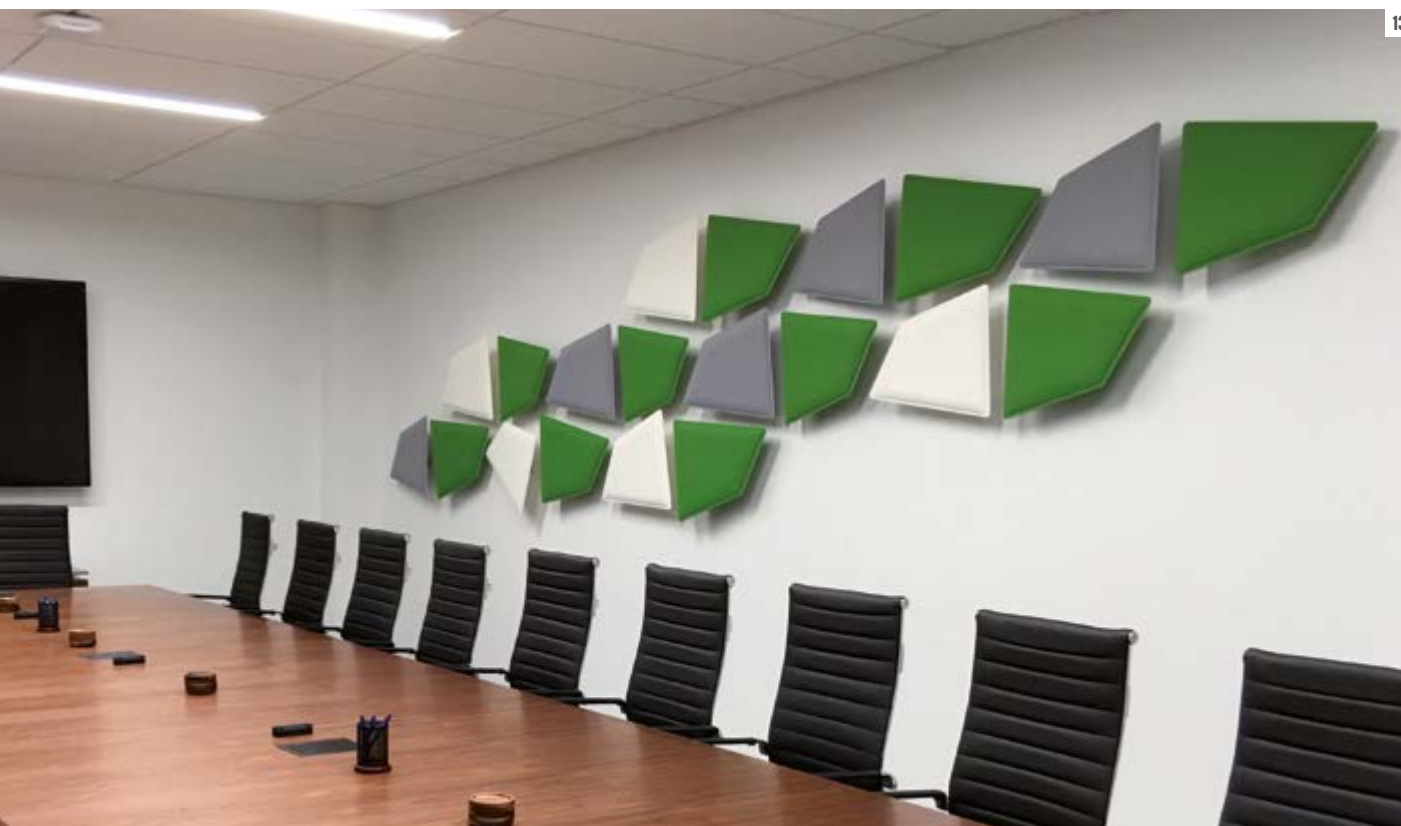

13

01/02_ Würth Elektronik Italia, Vimercate MB (Italy)
Products: MITESCO and SNOWDESK

03_ Conference room (Spain)
Product: MITESCO

04_ Farnesina, Ministero degli Affari Esteri
e della Cooperazione Internazionale, Roma (Italy)
Product: MITESCO

05_ KIA Motors Italia, Milano (Italy)
Product: FLAP

06_ BSI Monaco (Principality of Monaco)
Product: TRA

07_ Credem Leasing, Reggio Emilia (Italy)
Product: IN

08_ Office, Dallas (U.S.A.)
Product: FLAP

09_ Conference room, Napoli (Italy)
Product: MITESCO

10_ Meeting room, Napoli (Italy)
Product: FLAP

11_ Alvogen, (Malta)
Product: OVERSIZE

12_ Office, Milano (Italy)
Product: FLAP

13_ Conference room, Colorado (U.S.A.)
Product: FLAP



01



02



03



04



05



06 07



01_ Banca di Sardegna (Italy)
Product: MITESCO

02_ Sky, Milano (Italy)
Products: BAFFLE and MITESCO

03_ International bank, Roma (Italy)
Product: FLAP

04_ Caviar Sturia, Bordeaux (France)
Product: FLAP

05_ Office, Century City (U.S.A.)
Product: BAFFLE

06_ Conference room, California (U.S.A.)
Product: FLAP

07_ Corio Italia, Milano (Italy)
Product: FLAP

172
173



08

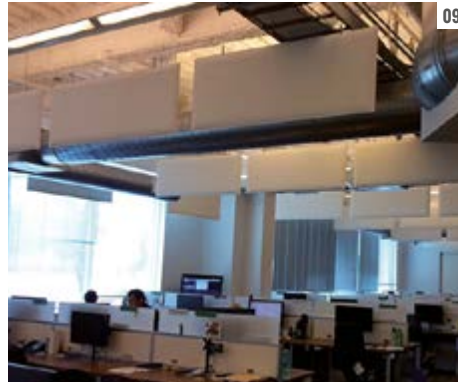

09



10



11



12

08_ Office (Netherlands)
Product: MITESCO

09_ Office, San Francisco (U.S.A.)
Product: BAFFLE

10_ CHG-Meridian, Vimercate MB (Italy)
Product: FLAP

11_ Office, California (U.S.A.)
Product: PLI OVERSIZE

12_ Gage Diamonds, Chicago (U.S.A.)
Product: FLAP

13_ Philips, Budapest (Hungary)
Product: FLAP

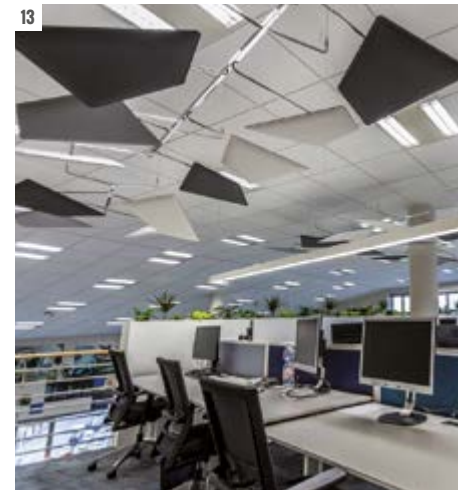

13

Projects

Public spaces & Museums



BUSINESS
nter

Villa Necchi Campiglio, FAI Fondo Ambiente Italiano, Milano (Italy)
Product: BAFFLE





Ospedale di Perugia (Italy)
Products: BAFFLE and MITESCO





Product: FLAP





Product: TRA

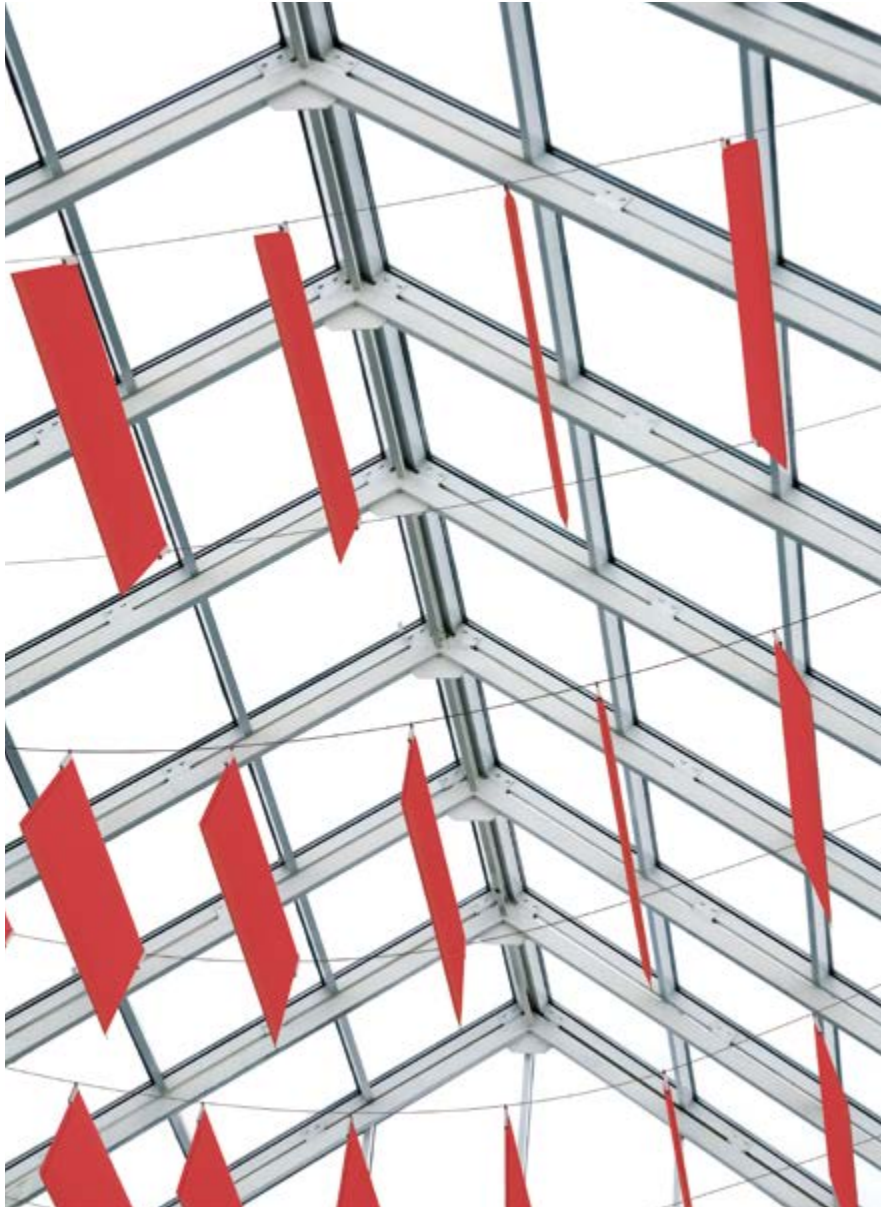

Product: BAFFLE



Product: FLAP



Product: SIPARIO



Product: TRA



Product: TRA



Product: BAFFLE



Product: FLAP

MUMAC Museo della macchina per caffè, Binasco MI (Italy)
Products: MITESCO and BAFFLE





Product: TRA



Product: FLAP

Product: PLI



Fondazione Arnaldo Pomodoro, Milano (Italy)
Product: MITESCO





01



02 04



03 05

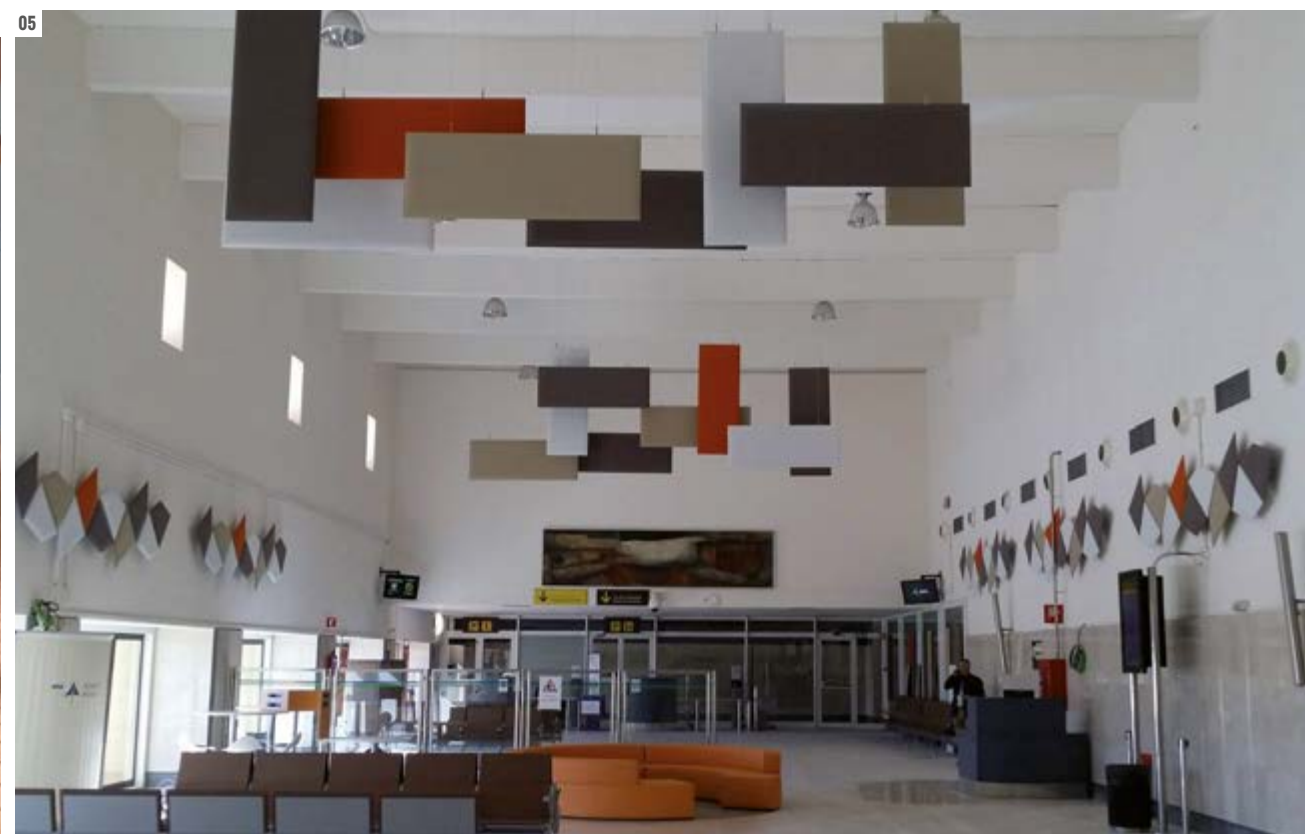
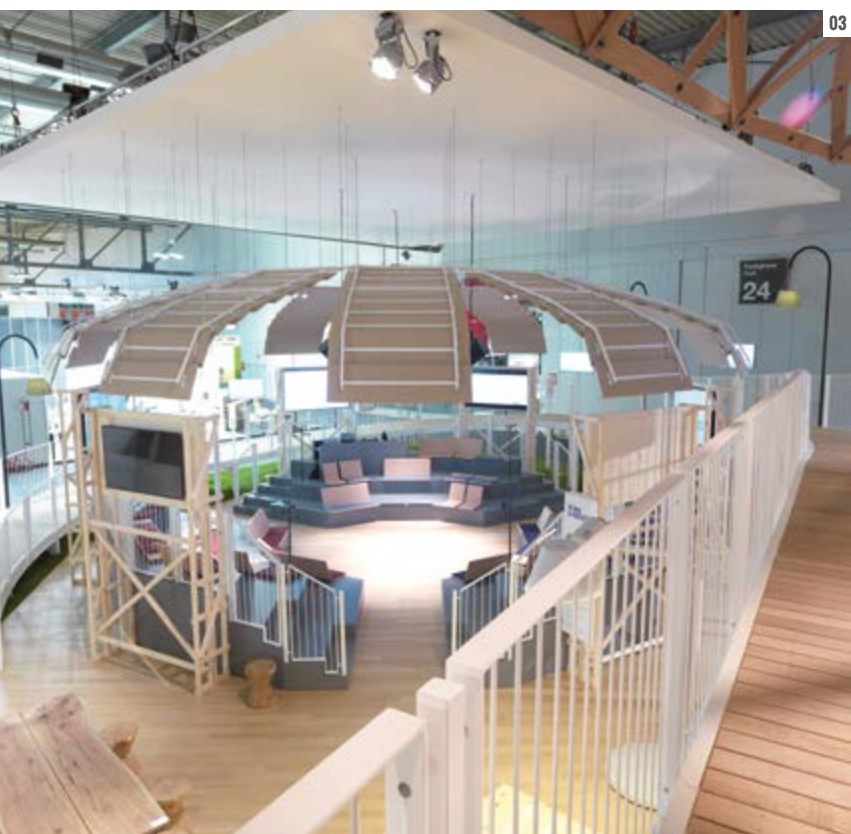



06



07

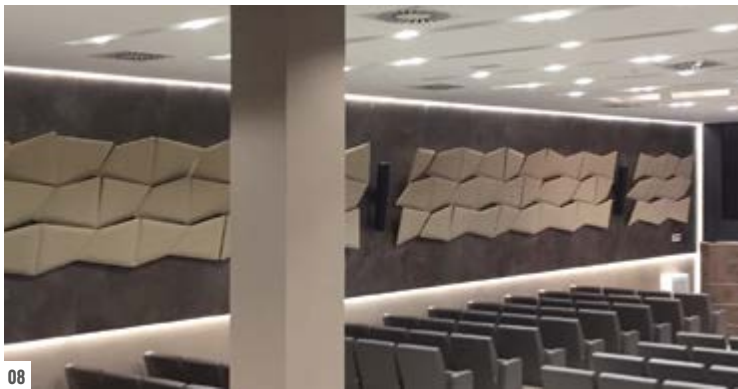

08



09

01_ NeoCon, quiet zone, Chicago (U.S.A.)

Products: MITESCO and COCKER

02_ Comune di Volpago del Montello TV (Italy)

Product: MITESCO

03_ The Walk - La Passeggiata by Michele De Lucchi,

Salone Ufficio, Nuova Fiera Milano, Rho (Italy)

Product: MITESCO

04_ Manifattura Tabacchi, Cagliari (Italy)

Product: BAFFLE

05_ Seville Airport (Spain)

Products: BAFFLE and FLAP

06_ Sidney Indesign show, Adaptive Interiors (Australia)

Product: BAFFLE

07_ C. Duin (Netherlands)

Product: SNOWFIX

08_ Rimini Banca (Italy)

Product: FLAP

09_ Salone Ufficio, Nuova Fiera Milano, Rho (Italy)

Product: BAFFLE

Projects

Education & Schools





University of California, Irvine (U.S.A.)
Products: FLAP and MITESCO



Babson College, Jeddah (Saudi Arabia)
Product: MITESCO







University, Milano (Italy)
Product: MITESCO



Woodbury University, Los Angeles (U.S.A.)
Product: MITESCO

O SERVICES
OUSLY ACCESSIBLE;
LEVERAGE
PERSONAL CLOUD





Product: SNOWSOFA

Biblioteca Mario Luzi, Firenze (Italy)
Product: FLAP



Product: MITESCO



196
197

Product: FLAP



01



03



06



07



02

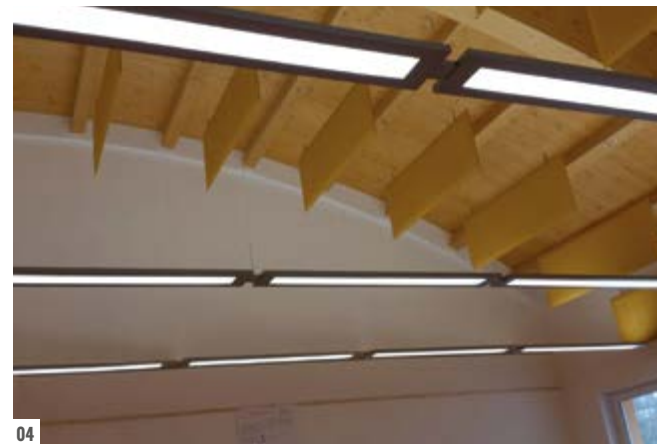

04



05



08



09



10



11



12



13

01_ Design 39 Campus, San Diego (U.S.A.)
Product: BAFFLE

02_ Biblioteca San Pellegrino (Italy)
Product: MITESCO

03_ School, Mississippi (U.S.A.)
Products: BAFFLE and FLAP

04_ School, Vezzano TN (Italy)
Product: BAFFLE

05_ Università di Bergamo (Italy)
Product: MITESCO

06_ Hubrecht Institute (Netherlands)
Product: PLI

07_ Politecnico di Milano (Italy)
Product: MITESCO

198

199

08_ Workshop room for students, Hilversum (Netherlands)
Products: FLAP and MITESCO

09_ Student house, Dresden (Germany)
Product: TRA

10_ Akademiet As, Drammen (Norway)
Product: MITESCO

11_ School, Rossau (Germany)
Product: MITESCO

12_ Camplus, Palermo (Italy)
Product: FLAP

13_ International School of Europe, Baranzate MI (Italy)
Product: MITESCO

Projects

Retail & Leisure





Products: BEMOLLE and DIESIS



Product: MITESCO

Product: FLAP



Product: FLAP





Product: MITESCO



Product: MITESCO

Projects

Restaurants, Cafès & Hotels





Product: DIESIS



Product: DIESIS

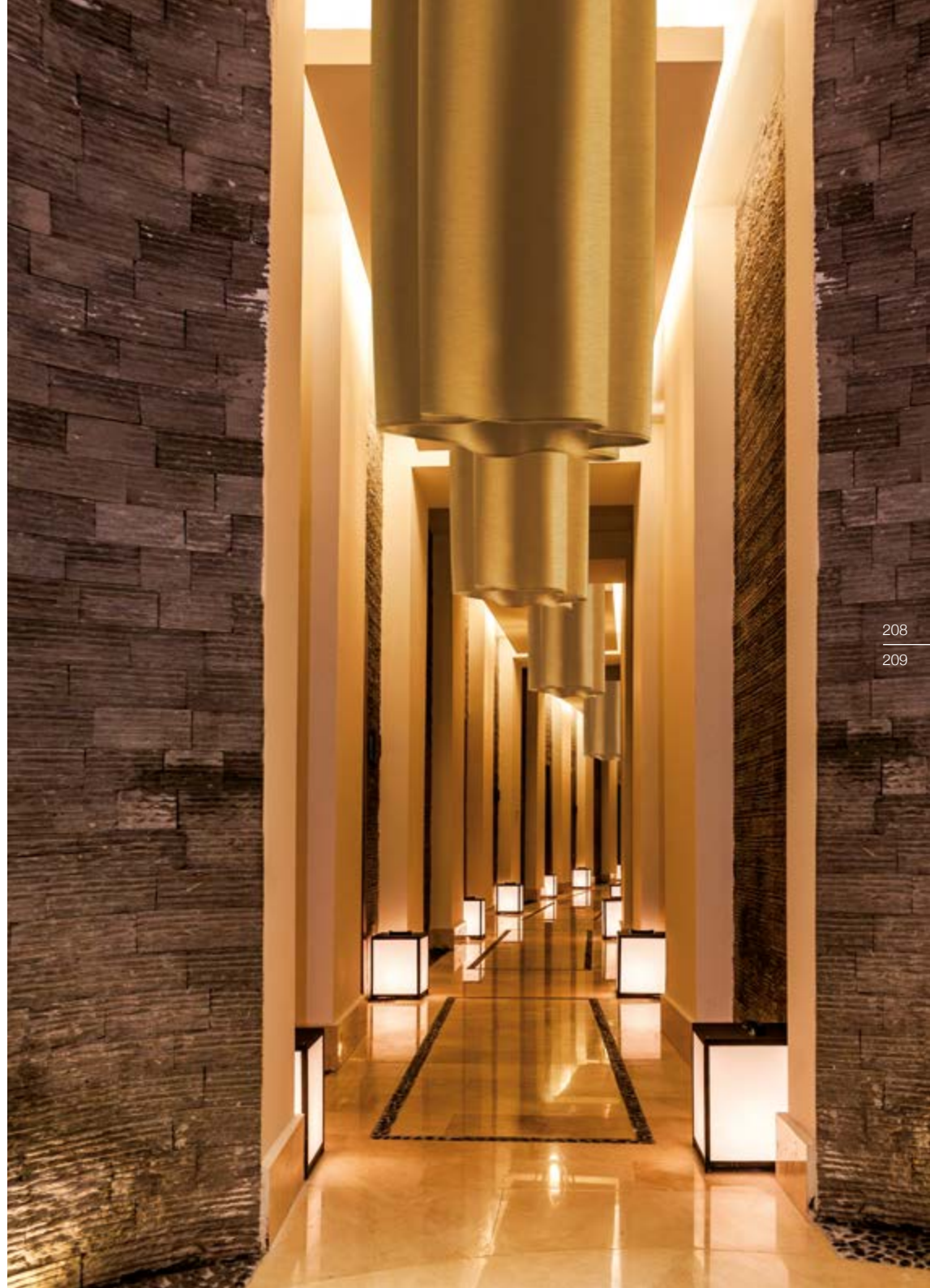

LAIT, Monza (Italy)
Products: BAFFLE and FLAP





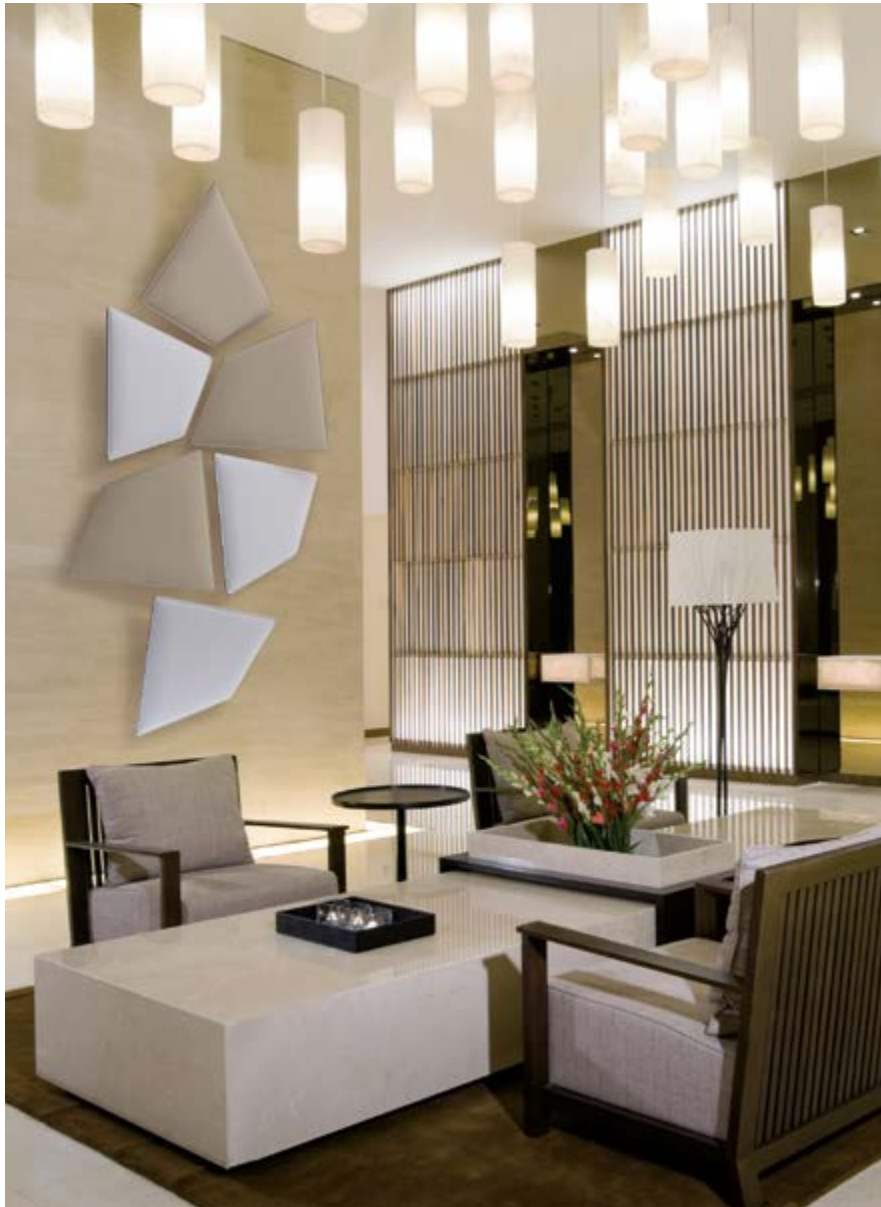

Product: FLAP

Product: FLAP



212

213



Product: FLAP



Product: MITESCO



214
215



Product: BEMOLLE

Product: V-FLAP



Product: DIESIS





Giacomo Arengario, Piazza Duomo, Milano (Italy)
Product: MITESCO



Giacomo Arengario, Piazza Duomo, Milano (Italy)
Product: BAFFLE

Camillo Benso, Milano (Italy)
Product: MITESCO



Identità Expo - Expo 2015, Milano (Italy)
Product: FLAP





Products: SNOWSOUND ART and SNOWFIX



Product: SNOWSOUND ART

Product: FLAP



Product: MITESCO





Product: FLAP



Product: OVERSIZE



Product: BAFFLE

Product: SNOWSOFA







01

04



02

05



03



01

04



06



07



01/02_ Gelateria Meringo, Ripi FR (Italy)
Products: MITESCO and BAFFLE

03_ La Virgule, Chauray (France)
Product: FLAP

04_ Hotel Villa Mercede, Frascati RM (Italy)
Product: MITESCO

05_ Bistrot Therme, Merano (Italy)
Product: MITESCO

06_ Fresco & Cimmino, Milano (Italy)
Product: MITESCO

07_ Mediterraneo Resort, Rimini (Italy)
Product: FLAP

08_ Pasticceria Savia, Catania (Italy)
Product: MITESCO

09_ Starbucks Coffee, Chicago (U.S.A.)
Product: FLAP



08

09





09



10



07



08



11

01_ Accà, Firenze (Italy)
Product: FLAP

02_ L'angolo di Napoli, Reggio Emilia (Italy)
Product: FLAP

03_ Berberè, Milano (Italy)
Product: OVERSIZE

04_ Meltemi, Parma (Italy)
Product: FLAP

05_ Narciso, Carpi MO (Italy)
Product: BAFFLE

06_ 12 morsi, Napoli (Italy)
Product: MITESCO

07_ Corte dei Medici, Catania (Italy)
Products: V-FLAP and MITESCO

08_ Restaurant, Capri (Italy)
Product: MITESCO

09_ Il Baiocco, Ferrara (Italy)
Product: MITESCO

10_ Roma Sparita, Roma (Italy)
Product: MITESCO

11_ Beardslee Public House, Washington State (U.S.A.)
Product: MITESCO

228

229

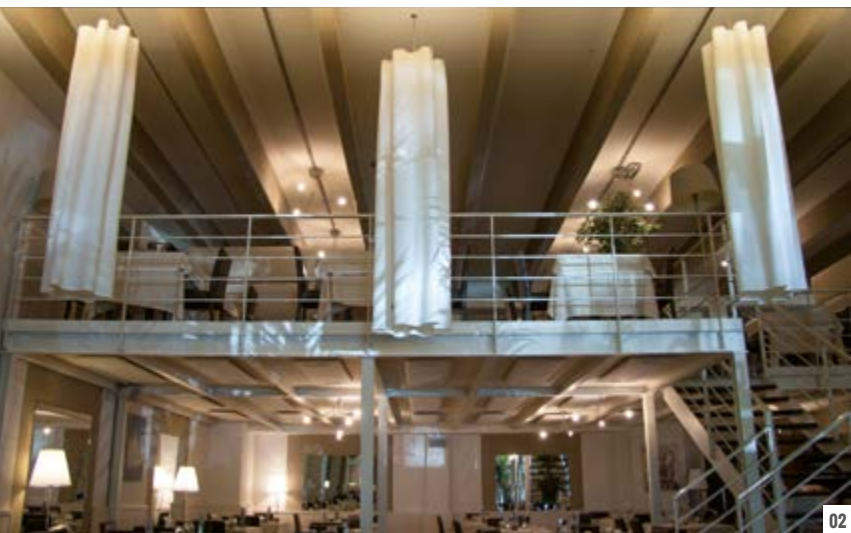



08 10



09



11



01_ Mamma Mia, Tà Xbiex (Malta)
Product: FLAP

02/03_ GRIG, Nova Milanese MB (Italy)
Products: DIESIS, MITESCO and FLAP

04_ Cafè de Mar, Acitrezza CT (Italy)
Product: MITESCO

05_ Zenzero, Catania (Italy)
Product: FLAP

06_ La Pâtisserie des Rêves, Milano (Italy)
Product: FLAP

07_ Gusto Giusto, Reggio Emilia (Italy)
Product: OVERSIZE

08_ Tre Farine, Caserta (Italy)
Product: BAFFLE

09_ Hotel (Spain)
Product: MITESCO

10_ Starita, Milano (Italy)
Product: BAFFLE

11_ Relais Blu, Amalfi Coast, Massa Lubrense NA (Italy)
Product: MITESCO

230

231



01



02

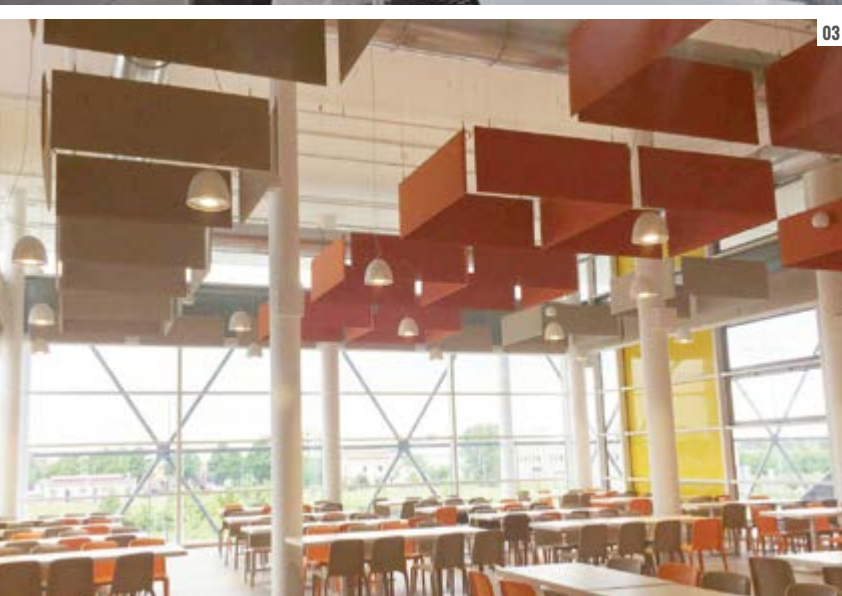

03



04

05





01_ Verdipapir Sentralen, Oslo (Norway)
Product: FLAP

02_ Ospedale San Giuseppe, Empoli (Italy)
Products: FLAP and MITESCO

03_ Conad, Forlì (Italy)
Product: BAFFLE

04_ Parco dei Tigli, Padova (Italy)
Product: BAFFLE

05_ Arnoldo Mondadori Editore, Segrate (Italy)
Products: FLAP and OVERSIZE

06_ Canteen, Binasco MI (Italy)
Product: OVERSIZE

07_ Canteen, Milano (Italy)
Product: MITESCO

08_ AON, Madrid (Spain)
Products: MITESCO and IN

09_ Rand Merchant Bank, Johannesburg (South Africa)
Product: MITESCO

232
233

Projects

Home

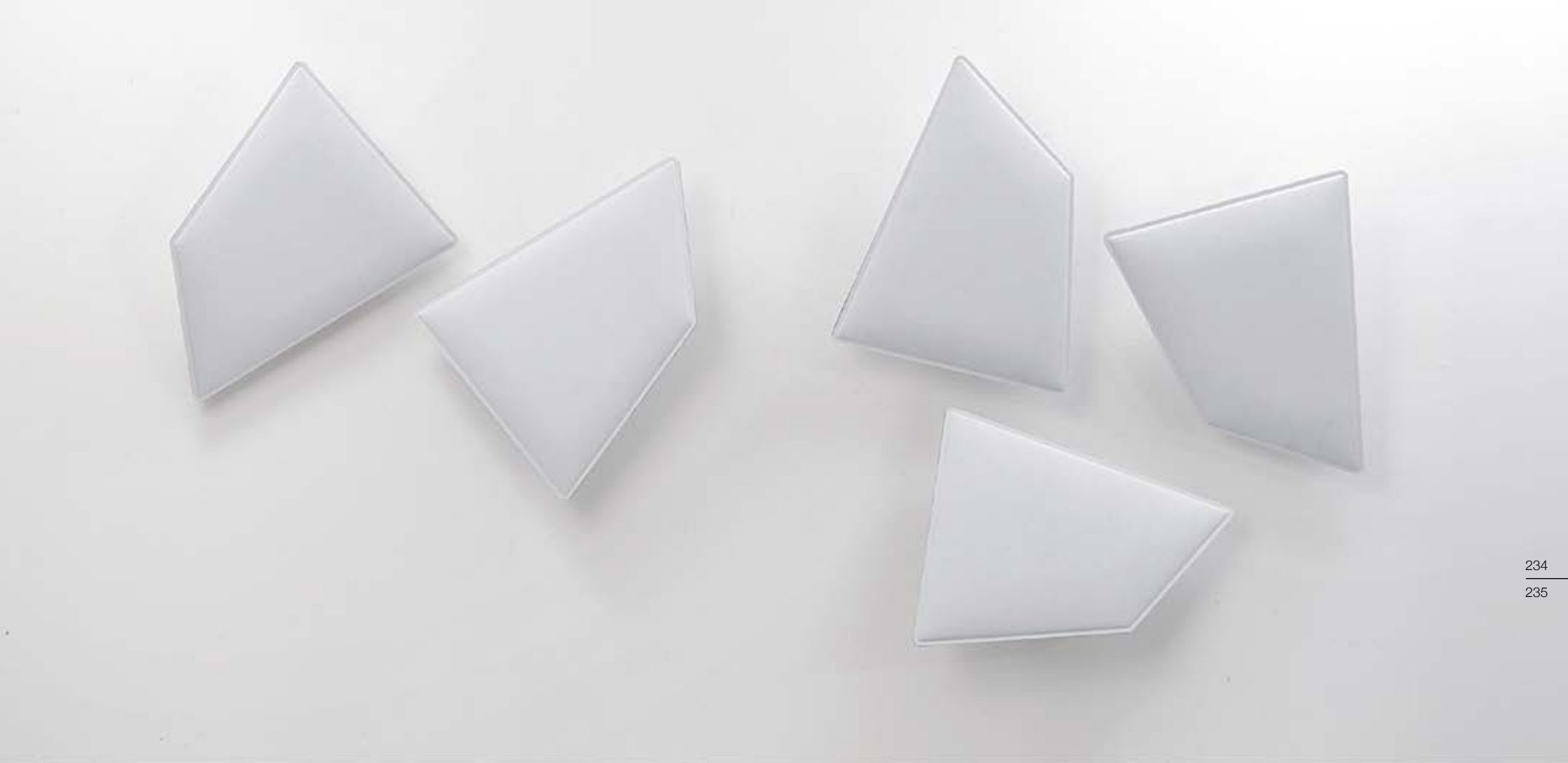

234
235

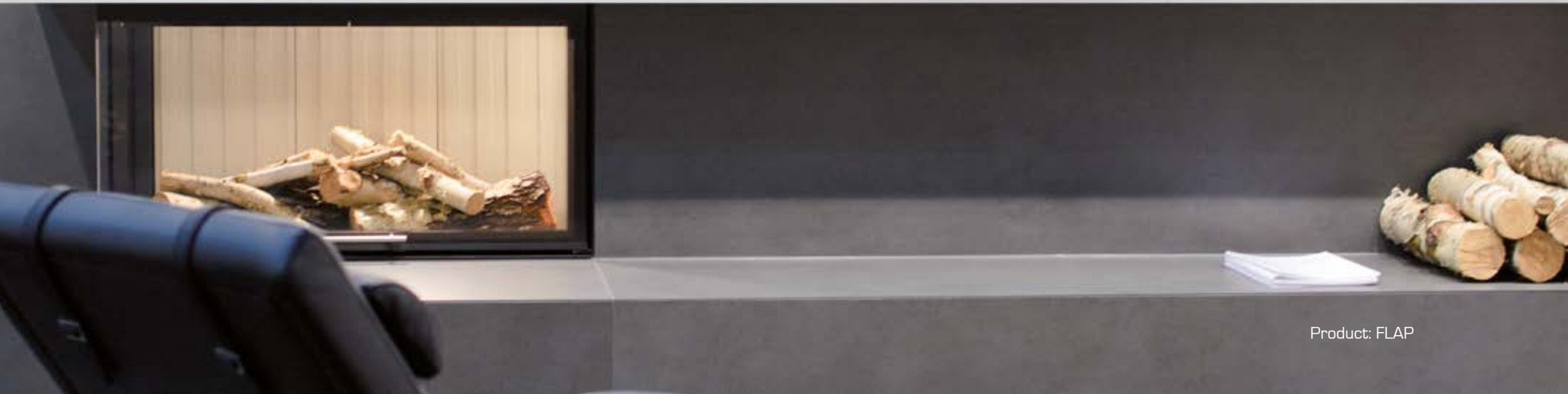

Product: FLAP





02 03



01_ Private house, Pelican Lake (U.S.A.)
Product: FLAP

02/03_ Private house, Groesbeek (Netherlands)
Product: FLAP

236
237

04



04_ Private house, Century City (U.S.A.)
Product: FLAP

Product: PALIO



Private house, Minnesota (U.S.A.)
Product: FLAP



Private house (U.S.A.)
Products: SIPARIO and FLAP

Product: FLAP



Product: FLAP



Projects

Audio & Music



corista

corista

Product: CORISTA

240
240

Products: FLAP and MITESCO



Product: CORISTA



Product: FLAP







02 03



01_ CTRL, Los Angeles (U.S.A.)
Product: MITESCO

02_ Radio Dynamo, Milano (Italy)
Products: DIESIS and FLAP

03_ Radio Yacht, Capri NA (Italy)
Product: FLAP

04_ Studi televisivi RAI (Italy)
Product: MITESCO



04





02 03



01_ Teatro della Triennale, Milano (Italy)
Product: MITESCO

02_ Pinaxa Studio, Milano (Italy)
Product: CORISTA

03_ Concerto Lorenzo Palmeri, La Triennale di Milano (Italy)
Product: CORISTA

04_ Istituto Musicale G. Lettimi, Rimini (Italy)
Product: MITESCO

246

247



04

I Caimi Brevetti S.p.A. si riserva, a proprio insindacabile giudizio, la facoltà di modificare senza preavviso i materiali costruttivi, le caratteristiche tecniche ed estetiche, nonché le dimensioni degli elementi illustrati nel presente catalogo le cui immagini e colori sono puramente indicativi. Il testo facente fede è esclusivamente quello in lingua italiana, le traduzioni hanno la finalità esclusiva di semplificarne la lettura. Prima di procedere all'acquisto dei prodotti illustrati nel presente catalogo consultate le condizioni di vendita nonché le caratteristiche tecniche e le avvertenze riportate nel listino prezzi in vigore.

EN Caimi Brevetti S.p.A. reserves, by its unappealable judgment, the right to modify without prior notice the building materials, the technical and aesthetic specifications, as well as the dimensions of the products in this catalogue, where pictures and colours are purely as an indication. The authentic text is only in Italian, the translation has the mere purpose of simplifying the reading. Prior to purchasing the products in this catalogue please consult the sale conditions and also the technical specifications and warnings in the current price list.

F Caimi Brevetti S.p.A. se réserve, à son jugement sans appel, la faculté de modifier sans aucun préavis les matériaux de construction, les caractéristiques techniques et esthétiques ainsi que les dimensions des éléments illustrés dans ce catalogue, dont les images et couleurs sont seulement indicatifs. Le text de référence est seulement celui en italien, les traductions ont le seul but de simplifier la lecture. Avant de procéder à l'achat des produits illustrés dans ce catalogue, consulter les conditions de vente, les caractéristiques techniques et les mises en garde reportées dans le tarif en vigueur.

D Caimi Brevetti S.p.A. behält sich das Recht vor, ihrer unanfechtbaren Entscheidung nach, verwendete Materialien, technische und ästhetische Details sowie die Abmessungen der in diesem Katalog abgebildeten Produkte ohne vorherige Ankündigung zu ändern. Die gezeigten Fotos und deren Farben dienen ausschliesslich zur ungefähren Information. Es ist ausschließlich der italienische Text verbindlich, die Übersetzungen dienen lediglich der vereinfachten Lesbarkeit. Es wird empfohlen, vor dem Erwerb der Artikel dieses Katalogs die Verkaufsbedingungen, die technischen Eigenschaften und Anweisungen in der gültigen Preisliste nachzusehen.

E Caimi Brevetti S.p.A. se reserva, a su indiscutible juicio, el derecho a modificar sin previo aviso los materiales de construcción, las características técnicas y estéticas, así como las medidas de los productos del presente catalogo, donde las imágenes y los colores son meramente indicativos. El texto auténtico es exclusivamente lo en idioma italiano, las traducciones tienen el único propósito de simplificar la lectura. Antes de comprar los productos ilustrados en este catálogo, consulten las condiciones de venta, las características técnicas y las advertencias indicadas en la lista de precios en vigor.

PROGETTO CREATIVO
interno20.it

FOTOGRAFIA
interno20.it
Luca Rotondo
Raoul Iacometti
Photo Beppe Raso
Dobran Laznik

Filippo Poli, 2015 © FAI - Fondo Ambiente Italiano

STAMPA
Geca

COPYRIGHT
Caimi Brevetti S.p.A. 2017

ARCHIVIO FOTOGRAFICO
Caimi Brevetti S.p.A.

DP278

Caimi
BREVETTI
SNOWSOUND DIVISION

Caimi Brevetti S.p.a.

Via Brodolini, 25/27
20834 Nova Milanese - MB - Italy
tel. 0362 49101
www.caimi.com

Ufficio vendite Italia

tel. 0362 491001
fax 0362 491060
vendite.italia@caimi.com

Export department

tel. (+39) 0362 491002
fax (+39) 0362 491061
export.dept@caimi.com

U.S.A. / Canada / Mexico

SNOWSOUND USA
10018 Santa Fe Springs Road
Santa Fe Springs, CA 90670
Tel. 562.903.9550
info@snowsoundusa.com
www.snowsoundusa.com



www.caimi.com