

Zoo



profim



“The goal was to design a broad range of visitor chairs in which all configurations can work equally successfully as stand-alone pieces. At the concept stage, we tried to find a structural approach that would enable achieving that task – the non arm, arm, cantilever and four leg versions all had equal priority. The result is a genuinely versatile chair range featured by discreet elegance.”

**Paul Brooks**  
Product Designer



**reddot** design award  
honourable mention 2015

Multifunctional. Multicolour.



# Perfect form, multiplied.

A truly multi-functional chair. Zoo is suitable for a variety of uses throughout the corporate environment including conference, meeting, training, retail and leisure areas. Zoo is available in a broad range of versions, finish options and colours, making it a versatile and adaptable choice for any space.









# Little details appreciated by big audiences.

Zoo stands out against other products in its class. The difference is in the attention to detail. With its beautifully integrated design and form Zoo doesn't feature any visible nuts, bolts or any other "connecting" elements, creating a seamless aesthetic within each individual chair throughout the range.











## Bold Monochrome.

Six component colours can be mixed and matched in a variety of ways. Or keep it simple with a single colour of plastic and metal elements throughout the chair to create a seamless monochrome experience.

# Professional or personal? Both, actually.

For a conference.

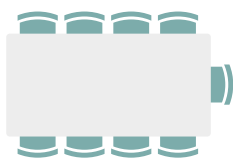

Example of a formal set-up – meeting room, auditorium, lecture room.

For a creative brainstorming session.

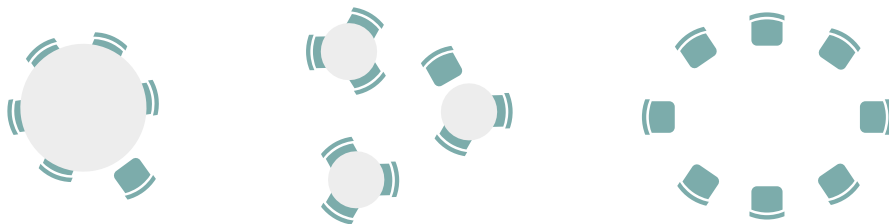

Example of an informal set-up – meeting room, cafeteria, discussion/focus groups.

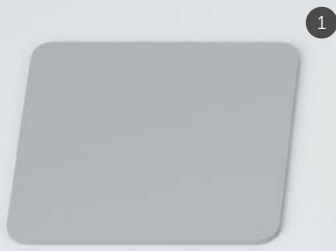

# Have fun creating your own.

Zoo allows for multiple configurations both functionally and colour-wise. As a result, there is a number of Zoo options that will perfectly complement any interior you need to accommodate.



- 1 bench table top
- 2 distance keeping elements for benches
- 3 plastic backrest
- 4 mesh backrest
- 5 upholstered backrest
- 6 plastic seat
- 7 upholstered seat
- 8 seat cover
- 9 armrest
- 10 cantilever without stacking option
- 11 cantilever with stacking option
- 12 4-legged frame
- 13 table top
- 14 bench glides
- 15 bench frame
- 16 numbering
- 17 "anti-panic" connector for rows
- 18 "anti-panic" connector for chairs
- 19 castors / glides
- 20 elements connecting frame with backrest
- 21 linking part (cantilever version)
- 22 linking part (4-legged version)

# Truly multifunctional.

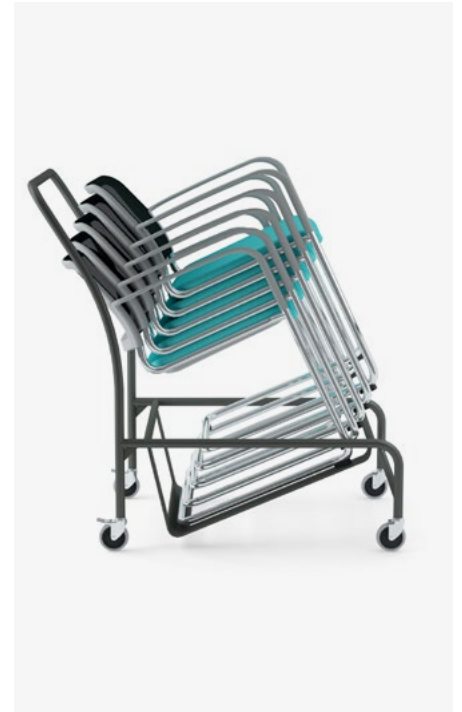

## Easy stacking and transport

The stackable version allows for economic storage when not in use, and a dedicated trolley makes transport much easier and faster.

## Folded table top

The optional table top makes Zoo a perfect choice for large seminar and lecture rooms.







## Combining in rows

A purposely designed row linking system means the chairs will remain in place even during long events.

## Chair & row numbering

Especially useful in case of big audience, the row and seat numbering option makes logistics of large events much easier.

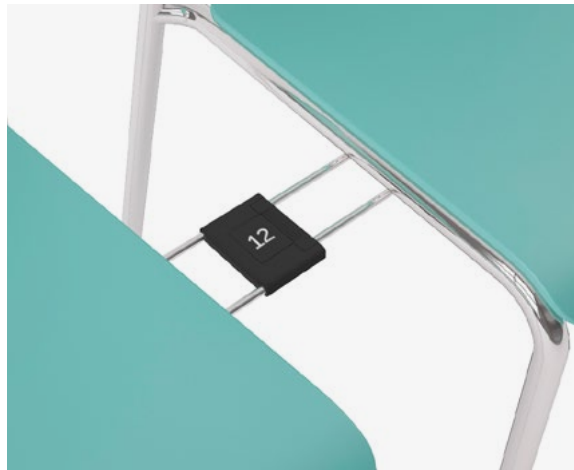

## "Anti-panic" system

Guarantees safety of all users even in emergency situations.

# Configure your product

When ordering, please use code symbols.

Zoo

5

Seat<sup>1</sup>

Backrest

Frame



Plastic

2



Plastic

2



Upholstered

0

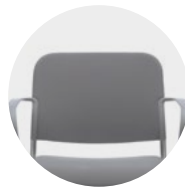

Upholstered

0<sup>2</sup>



Mesh

5



Legs

H



Legs with castors

HC



Cantilever with stacking option<sup>3,4</sup>

V



Cantilever without stacking option<sup>3,4</sup>

VN



Bench

L2 / L1B<sup>5</sup>

2-seat / 1 seat and table top

L3 / L2B<sup>5</sup>

3-seat / 2-seat and table top

L4 / L3B<sup>5</sup>

4-seat / 3-seat and table top

L5 / L4B<sup>5</sup>

5-seat / 4-seat and table top

<sup>1</sup> Seat cover:

- black frame – cover always black (RAL 9005),
- metallic, chrome, satine, RAL frame – cover always grey (RAL 7005) except for chairs with black plastic seat – in that case cover is always black (RAL 9005).

<sup>2</sup> Available only in version with upholstered seat (500).





<sup>3</sup> In versions on cantilever (V/VN) it is possible to order the chair without glides.

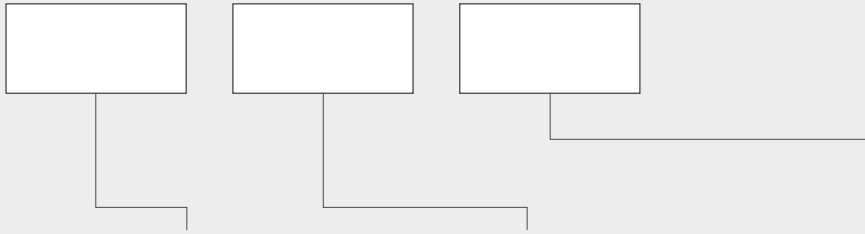



<sup>4</sup> Zoo on cantilever without armrests (V/VN versions) cannot be offered and distributed in the Federal Republic of Germany.

<sup>5</sup> Zoo benches are available with table top instead of seat. Colours of HPL (LW): LW01 (white), LW02 (black), LW04 (grey).



### Frame colour<sup>6</sup>

	
BLACK	METALLIC
	
CHROME	SATINE

	
RAL 9016	RAL 1000
	
RAL 2012	RAL 6034

RAL 7005

<sup>6</sup> RAL colours are not applicable in benches.

### Armrests/Table top<sup>7</sup>



Polyamide armrest

2P









Table top

Always assembled on the right side of the chair

2PB

<sup>7</sup> Not applicable in benches.

### Plastic colours<sup>8</sup>

	
RAL 9016	RAL 1000
	
RAL 2012	RAL 6034
	
RAL 7005	RAL 9005

<sup>8</sup> It is possible to freely join the colours of seat, backrest and armrests.

### Upholstery

Type & colour

SYMBOL

#### Mesh



		
RU-17	RU-15	RU-16
		
SR-15	SR-16	

### Additional

Glides

HARD	FELT	TEFLON
For soft floors.	For hard floors.	Universal.

Castors

	
HARD	SOFT
For soft floors.	For hard floors.

Castors are equipped with a brake that prevents the chair from "moving away" without a load.

# Accessories

When ordering, please use code symbols.

## Numbering



Chair numbering Type A

**ZA 1-10** Numbers 1-10 (a set)

**ZA 11-20** Numbers 11-20 (a set)

**ZA 21-30** Numbers 21-30 (a set)



Chair numbering Type B

**ZB 1-10** Numbers 1-10 (a set)

**ZB 11-20** Numbers 11-20 (a set)

**ZB 21-30** Numbers 21-30 (a set)



Rows numbering

**ZC 1-10** Numbers 1-10 (a set)

**ZC 11-20** Numbers 11-20 (a set)

## Magnetic handle



Magnetic handle for disassembly of the numbering

**MH**

## Joining in rows

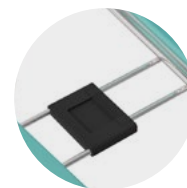

Linking part (4-legged version)<sup>1</sup>



Linking part (cantilever version)

<sup>1</sup> The linking part is suitable for 4-legged versions (H/H 2P/H 2PB). The linking part is an integral part of the chair, therefore it cannot be purchased and assembled at a later stage.

## "Anti-panic" system<sup>2,3</sup>



### "Anti-panic" connectors

- APA** for chairs without armrests
- APB** for chairs with armrests
- APC** for chairs with armrests and a table top



### "Anti-panic" system for connecting rows

**APD**

<sup>2</sup> Available colours: black, metallic.

<sup>3</sup> "Anti-panic" system is available for 4-legged versions only (H/H 2P/H 2PB).

## Trolley for transportation<sup>4</sup>



### Trolley without a handle

**CT**



### Trolley with a handle

**CTH**

<sup>4</sup> Available colours: black, metallic. Always with soft castors.

## Distance keeping elements<sup>5</sup>



### Distance keeping element preventing touching the wall by the backrests of benches

**D1**



### Distance keeping elements preventing touching of backrests of adjacent benches

**D2**

<sup>5</sup> Available colours: black, metallic.

# Measurements

The measurements are approximate and can differ depending on the product configuration.  
Measuring methodology is available at this link: [www.profim.eu/Measuring\\_methodology.pdf](http://www.profim.eu/Measuring_methodology.pdf)

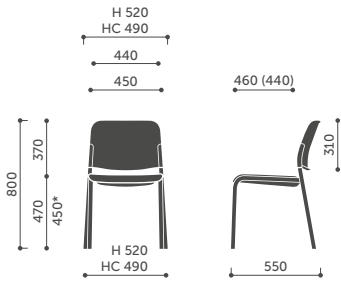

522H / 522HC  
525H / 525HC

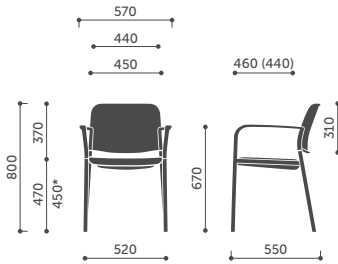

522H 2P / 522HC 2P  
525H 2P / 525HC 2P

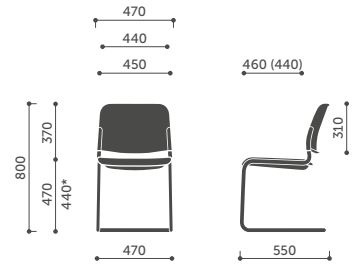

522V / 522VN  
525V / 525VN

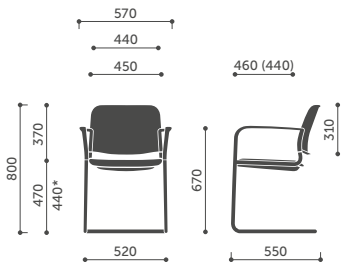

522V 2P / 522VN 2P  
525V 2P / 525VN 2P

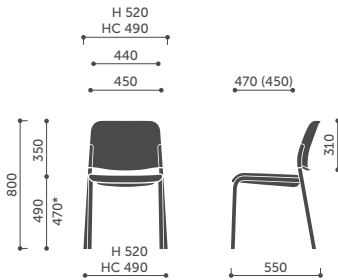

502H / 502HC  
505H / 505HC  
500H / 500HC

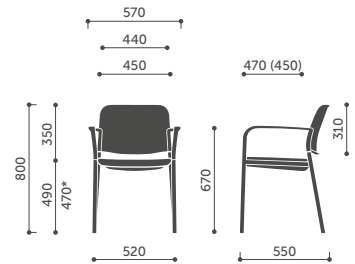



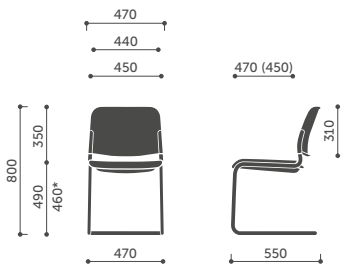

502H 2P / 502HC 2P  
505H 2P / 505HC 2P  
500H 2P / 500HC 2P

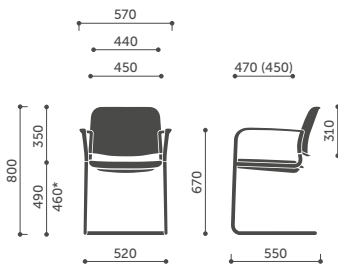

502V / 502VN  
505V / 505VN  
500V / 500VN



502V 2P / 502VN 2P  
505V 2P / 505VN 2P  
500V 2P / 500VN 2P

	522H (+2P) x10	502V (+2P) x5'
	522V (+2P) x8	500H (+2P) x5'
	525H (+2P) x10	500V (+2P) x5'
	525V (+2P) x8	505H (+2P) x5'
	502H (+2P) x5'	505V (+2P) x5'
	522H x12	502H (+2P) x5'
	522H 2P x10	502V (+2P) x5'
	522V (+2P) x8	500H (+2P) x5'
	525H x12	500V (+2P) x5'
	525H 2P x10	505H (+2P) x5'
	525V (+2P) x8	505V (+2P) x5'
	522H 2PB x5	502V 2PB x5'
	522V 2PB x5	500H 2PB x5'
	525H 2PB x5	500V 2PB x5'
	525V 2PB x5	505H 2PB x5'
	502H 2PB x5'	505V 2PB x5'
	522H 2PB x5	502V 2PB x5'
	522V 2PB x5	500H 2PB x5'
	525H 2PB x5	500V 2PB x5'
	525V 2PB x5	505H 2PB x5'
	502H 2PB x5'	505V 2PB x5'

\* Seat height is measured according to PN EN 16139 norm (with seat burden).



\* Chairs upholstered in Valencia – 3 pcs.

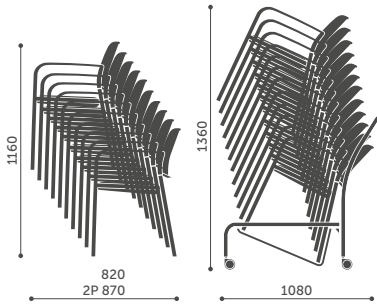

stacking 522H

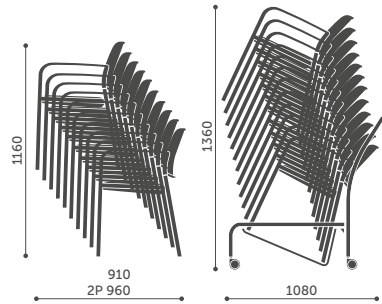

stacking 525H

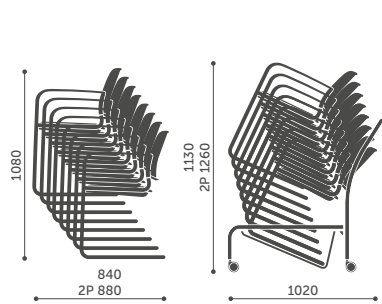

stacking 522V

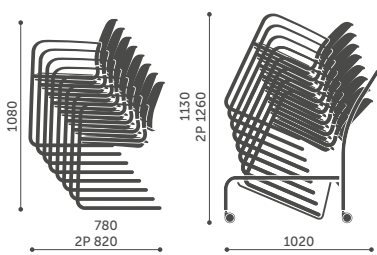

stacking 525V

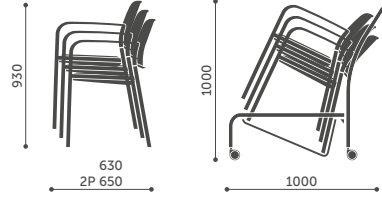

stacking 502H  
stacking 500H  
stacking 505H

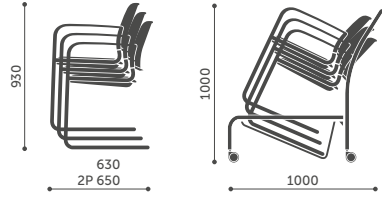

stacking 502V  
stacking 500V  
stacking 505V

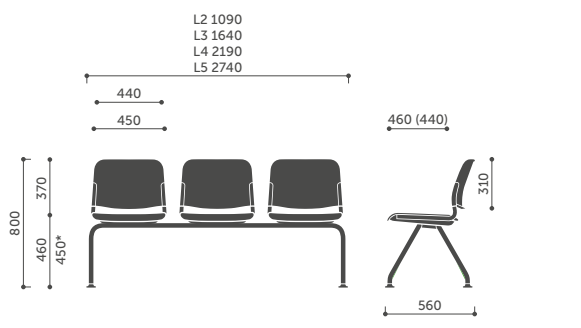

522L / 525L

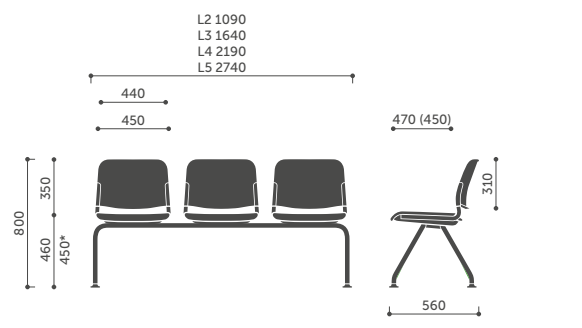

502L / 505L

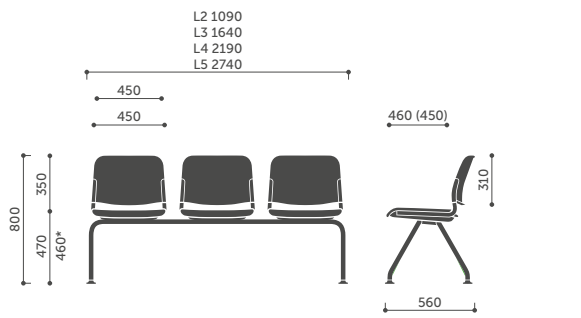

500L

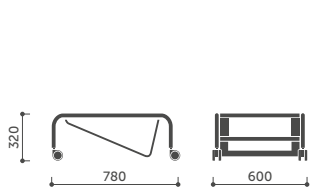

CT

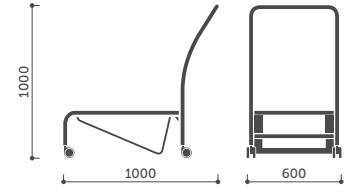

CTH

# Profim and the Environment

In our operation we follow the sustainability principle. We operate in a responsible manner for the benefit of our customers, employees, suppliers, and the local community, but we always respect the environment.

In order to achieve our goals, we have implemented Environmental Management System based on the ISO 14001 standard, which allows for a comprehensive approach to ecology. We take into consideration and evaluate the way Zoo products affect the environment during their entire life cycle.

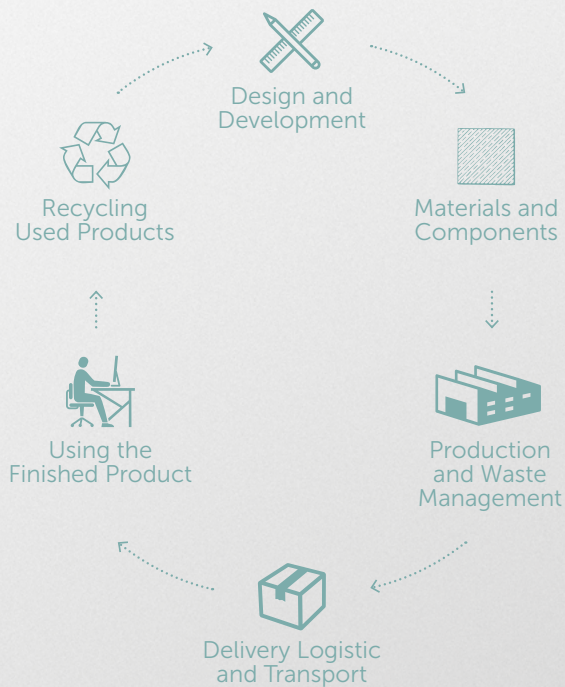

For more information about the product please scan the QR code.

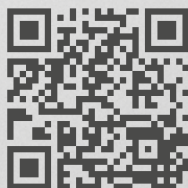

# Zoo

## Product Environmental Information

(for Zoo 522H 2P)

Materials used:

Metals	kg	%
Steel	4.06	53.8
Aluminium	0.11	1.45
Plastics	kg	%
Polyamide (PA)	0.63	8.35
Polypropylene (PP)	2.75	36.4
Weight	7.55	100

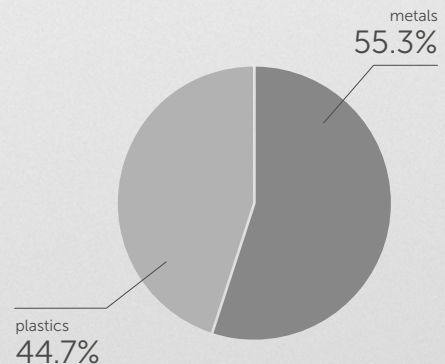

Recyclable content



This product contains no chemical compounds harmful to human health or the environment (including PVC, chromium (VI), mercury or lead).



[www.profim.eu](http://www.profim.eu)

The producer reserves the right to conduct construction changes and improvements of the products.  
Colours presented in the catalogue may vary from the original colours of furniture.



**CHROMIUM (III)**  
Eco-Friendly Technology

**CHROM (III)**  
Umweltfreundliche  
Technologie

